

# USER MANUAL



## **Meta IX-6 INVERTER / CHARGER**

Version: 1.0

# Table Of Contents

|  |           |
|--|-----------|
| <b>ABOUT THIS MANUAL</b> .....                                       | <b>1</b>  |
| Purpose.....   | 1         |
| Scope.....   | 1         |
| <b>SAFETY INSTRUCTIONS</b> .....                                     | <b>1</b>  |
| <b>INTRODUCTION</b> .....  | <b>2</b>  |
| Product Overview.....  | 3         |
| <b>INSTALLATION</b> .....  | <b>4</b>  |
| Unpacking and Inspection.....  | 4         |
| Preparation .....  | 4         |
| Mounting the Unit.....   | 4         |
| Battery Connection .....   | 5         |
| AC Input/Output Connection.....                                      | 6         |
| PV Connection .....  | 7         |
| Final Assembly.....  | 8         |
| Communication Connection.....  | 9         |
| Dry Contact Signal.....  | 9         |
| <b>OPERATION</b> .....   | <b>10</b> |
| Power ON/OFF .....   | 10        |
| Operation and Display Panel .....                                    | 10        |
| LCD Display Icons .....  | 11        |
| LCD Setting.....   | 14        |
| Display Setting .....  | 27        |
| Operating Mode Description .....                                     | 31        |
| <b>BATTERY EQUALIZATION</b> .....                                    | <b>37</b> |
| <b>CLEARANCE AND MAINTENANCE FOR ANTI-DUST KIT</b> .....             | <b>38</b> |
| Overview .....   | 38        |
| Clearance and Maintenance.....                                       | 38        |
| <b>SPECIFICATIONS</b> .....  | <b>39</b> |
| <b>TROUBLE SHOOTING</b> .....  | <b>40</b> |
| <b>Appendix I: Parallel function</b> .....                           | <b>41</b> |
| <b>Appendix II: BMS Communication Installation</b> .....             | <b>58</b> |
| <b>Appendix III: The Wi-Fi Operation Guide in Remote Panel</b> ..... | <b>65</b> |

# ABOUT THIS MANUAL

## Purpose

This manual describes the assembly, installation, operation and troubleshooting of this unit. Please read this manual carefully before installations and operations. Keep this manual for future reference.

## Scope

This manual provides safety and installation guidelines as well as information on tools and wiring.

# SAFETY INSTRUCTIONS



**WARNING: This chapter contains important safety and operating instructions. Read and keep this manual for future reference.**

1. Before using the unit, read all instructions and cautionary markings on the unit, the batteries and all appropriate sections of this manual.
2. **CAUTION** --To reduce risk of injury, charge only deep-cycle lead acid type rechargeable batteries. Other types of batteries may burst, causing personal injury and damage.
3. Do not disassemble the unit. Take it to a qualified service center when service or repair is required. Incorrect re-assembly may result in a risk of electric shock or fire.
4. To reduce risk of electric shock, disconnect all wirings before attempting any maintenance or cleaning. Turning off the unit will not reduce this risk.
5. **CAUTION** – Only qualified personnel can install this device with battery.
6. **NEVER** charge a frozen battery.
7. For optimum operation of this inverter/charger, please follow required spec to select appropriate cable size. It's very important to correctly operate this inverter/charger.
8. Be very cautious when working with metal tools on or around batteries. A potential risk exists to drop a tool to spark or short circuit batteries or other electrical parts and could cause an explosion.
9. Please strictly follow installation procedure when you want to disconnect AC or DC terminals. Please refer to INSTALLATION section of this manual for the details.
10. Fuses are provided as over-current protection for the battery supply.
11. GROUNDING INSTRUCTIONS -This inverter/charger should be connected to a permanent grounded wiring system. Be sure to comply with local requirements and regulation to install this inverter.
12. NEVER cause AC output and DC input short circuited. Do NOT connect to the mains when DC input short circuits.
13. **Warning!!** Only qualified service persons are able to service this device. If errors still persist after following troubleshooting table, please send this inverter/charger back to local dealer or service center for maintenance.

# INTRODUCTION

This hybrid PV inverter can provide power to connected loads by utilizing PV power, utility power and battery power.

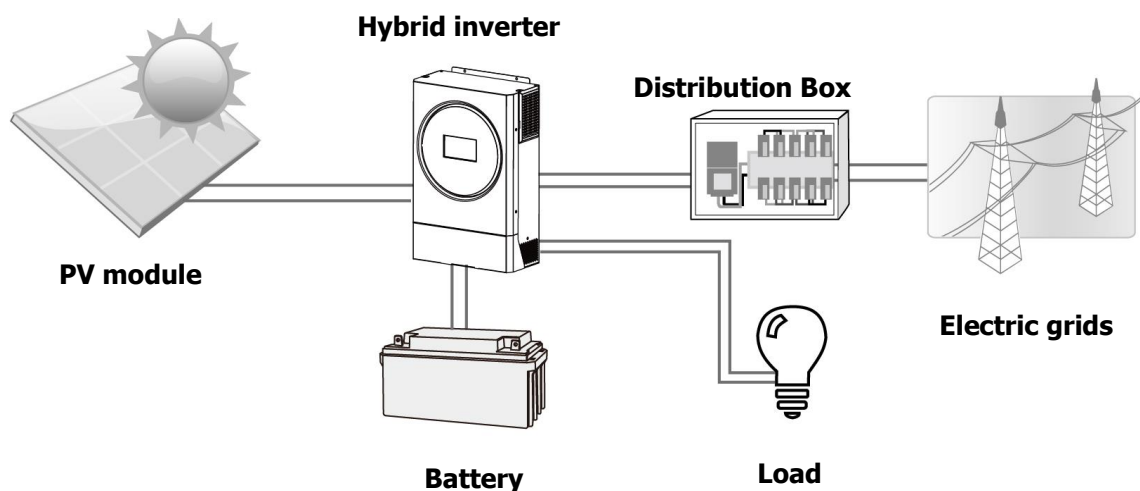

**Figure 1 Basic hybrid PV System Overview**

Depending on different power situations, this hybrid inverter is designed to generate continuous power from PV solar modules (solar panels), battery, and the utility. When MPP input voltage of PV modules is within acceptable range (see specification for the details), this inverter is able to generate power to feed the grid (utility) and charge battery. **Never connect the positive and negative terminals of the solar panel to the ground.** See Figure 1 for a simple diagram of a typical solar system with this hybrid inverter.

## Product Overview

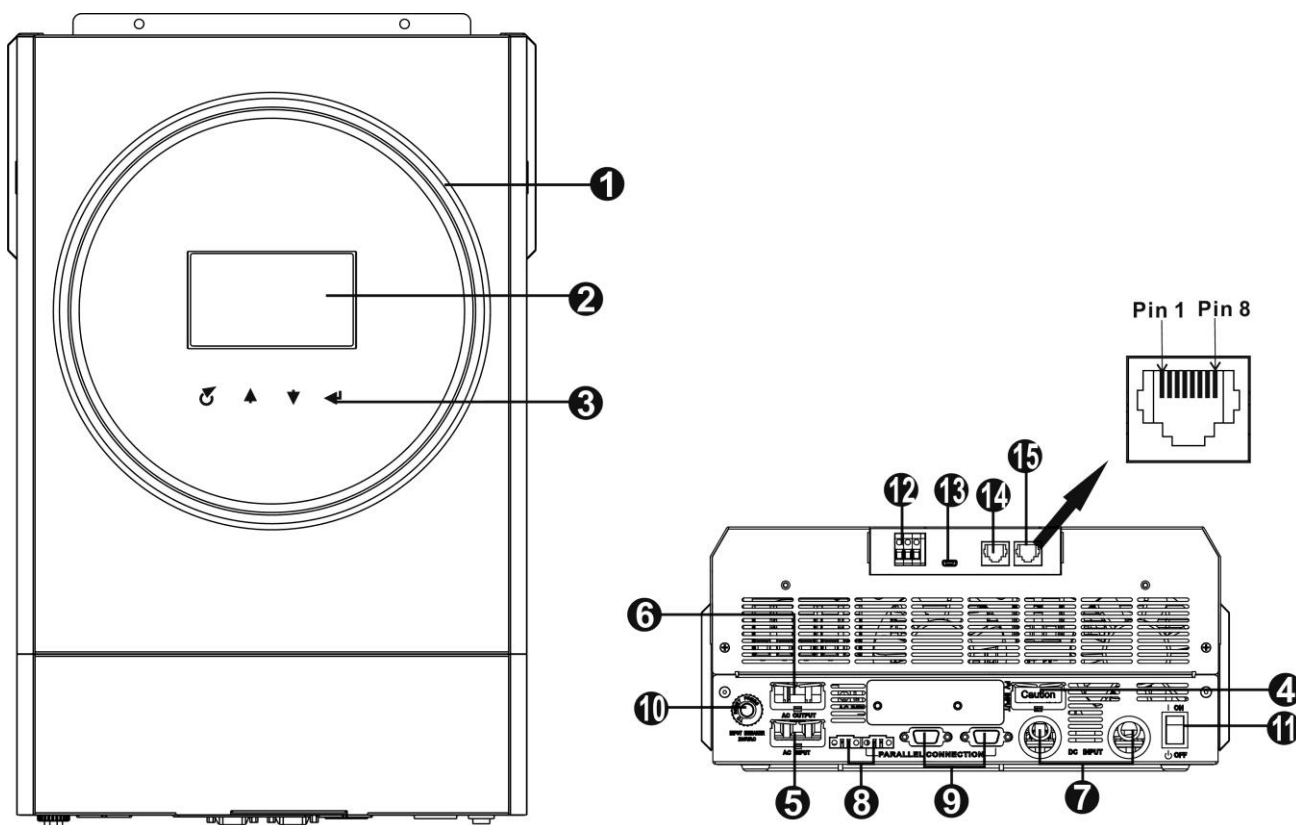

**NOTE:** For parallel installation and operation, please check *Appendix I*.

1. RGB LED ring (refer to LCD Setting section for the details)
2. LCD display
3. Function buttons
4. PV connectors
5. AC input connectors
6. AC output connectors (Load connection)
7. Battery connectors
8. Current sharing port
9. Parallel communication port
10. Circuit breaker
11. Power switch
12. Dry contact
13. USB port as USB communication port and USB function port
14. RS-232 communication port
15. BMS communication port: CAN, RS-485 or RS-232

# INSTALLATION

## Unpacking and Inspection

Before installation, please inspect the unit. Be sure that nothing inside the package is damaged. You should have received the following items inside of package:

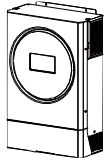

Inverter



CD



User manual



Communication cable

## Preparation

Before connecting all wirings, please take off bottom cover by removing two screws as shown below.

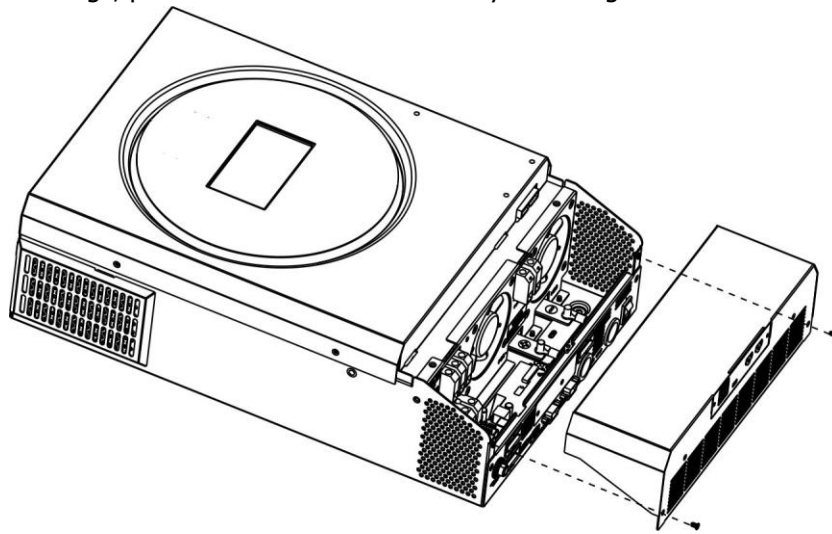

## Mounting the Unit

Consider the following points before selecting where to install:

- Do not mount the inverter on flammable construction materials.
- Mount on a solid surface.
- Install this inverter at eye level in order to allow the LCD display to be read at all times.
- The ambient temperature should be between  $-10^{\circ}\text{C}$  and  $50^{\circ}\text{C}$  to ensure optimal operation.
- The recommended installation position is to be adhered to the wall vertically.
- Be sure to keep other objects and surfaces as shown in the right diagram to guarantee sufficient heat dissipation and to have enough space for removing wires.

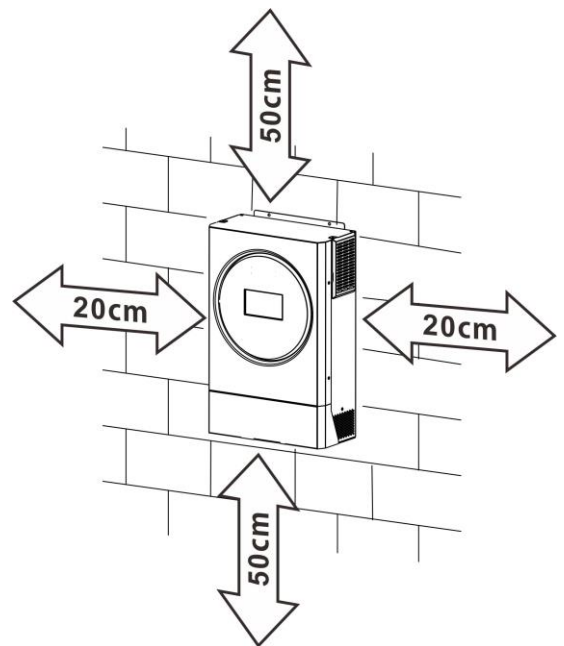

**SUITABLE FOR MOUNTING ON CONCRETE OR OTHER NON-COMBUSTIBLE SURFACE ONLY.**

Install the unit by screwing three screws. It's recommended to use M4 or M5 screws.

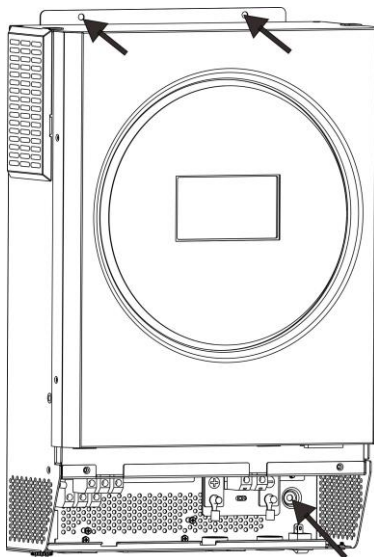

## Battery Connection

**CAUTION:** For safety operation and regulation compliance, it's requested to install a separate DC over-current protector or disconnect device between battery and inverter. It may not be requested to have a disconnect device in some applications, however, it's still requested to have over-current protection installed. Please refer to typical amperage in below table as required fuse or breaker size.

**WARNING!** All wiring must be performed by a qualified personnel.

**WARNING!** It's very important for system safety and efficient operation to use appropriate cable for battery connection. To reduce risk of injury, please use the proper recommended cable and terminal size as below.

**Ring terminal:**

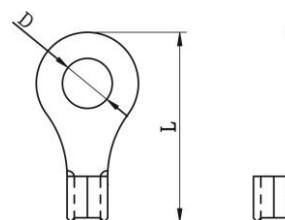

**Recommended battery cable and terminal size:**

| Model     | Typical Amperage | Battery Capacity | Wire Size        | Ring Terminal         |            |        | Torque Value |
|-----------|------------------|------------------|------------------|-----------------------|------------|--------|--------------|
|           |                  |                  |                  | Cable mm <sup>2</sup> | Dimensions |        |              |
|           |                  |                  |                  |                       | D (mm)     | L (mm) |              |
| Meta IX-6 | 137A             | 200AH            | 1*2AWG or 2*6AWG | 28                    | 6.4        | 42.7   | 2~3 Nm       |

Please follow below steps to implement battery connection:

1. Assemble battery ring terminal based on recommended battery cable and terminal size.
2. Insert the ring terminal of battery cable flatly into battery connector of inverter and make sure the nuts are tightened with torque of 2-3 Nm. Make sure polarity at both the battery and the inverter/charge is correctly connected and ring terminals are tightly screwed to the battery terminals.

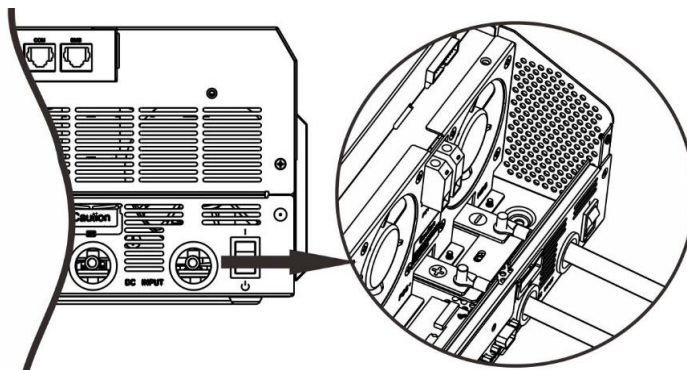

**WARNING: Shock Hazard**

Installation must be performed with care due to high battery voltage in series.



**CAUTION!!** Do not place anything between the flat part of the inverter terminal and the ring terminal. Otherwise, overheating may occur.

**CAUTION!!** Do not apply anti-oxidant substance on the terminals before terminals are connected tightly.

**CAUTION!!** Before making the final DC connection or closing DC breaker/disconnector, be sure positive (+) must be connected to positive (+) and negative (-) must be connected to negative (-).

## AC Input/Output Connection

**CAUTION!!** Before connecting to AC input power source, please install a **separate** AC breaker between inverter and AC input power source. This will ensure the inverter can be securely disconnected during maintenance and fully protected from over current of AC input.

**CAUTION!!** There are two terminal blocks with "IN" and "OUT" markings. Please do NOT mis-connect input and output connectors.

**WARNING!** All wiring must be performed by a qualified personnel.

**WARNING!** It's very important for system safety and efficient operation to use appropriate cable for AC input connection. To reduce risk of injury, please use the proper recommended cable size as below.

### Suggested cable requirement for AC wires

| Model     | Gauge  | Torque Value |
|-----------|--------|--------------|
| Meta IX-6 | 10 AWG | 1.2~ 1.6 Nm  |

Please follow below steps to implement AC input/output connection:

1. Before making AC input/output connection, be sure to open DC protector or disconnector first.
2. Remove insulation sleeve 10mm for eight conductors. And shorten phase L and neutral conductor 3 mm.
3. Insert AC input wires according to polarities indicated on terminal block and tighten the terminal screws. Be sure to connect PE protective conductor (⊕) first.

⊕ → **Ground (yellow-green)**

**L** → **LINE (brown or black)**

**N** → **Neutral (blue)**

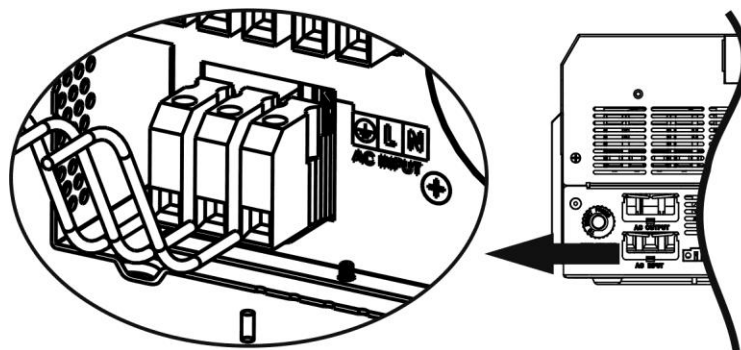

### WARNING:

Be sure that AC power source is disconnected before attempting to hardwire it to the unit.

4. Then, insert AC output wires according to polarities indicated on terminal block and tighten terminal screws. Be sure to connect PE protective conductor (⊕) first.

⊕ → **Ground (yellow-green)**

**L1** → **LINE (brown or black)**



**N1→Neutral (blue)**

**L2→LINE (brown or black)**

**N2→Neutral (blue)**

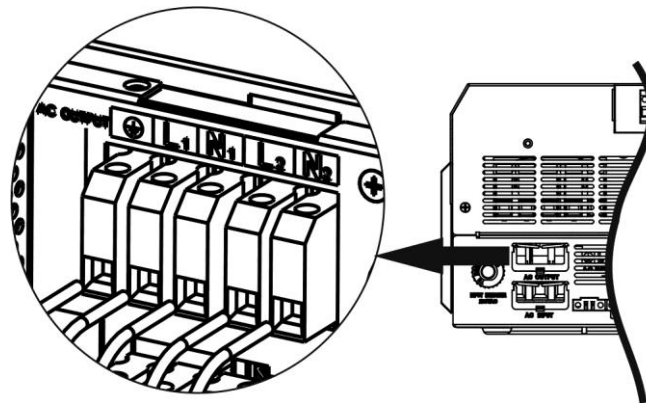

5. Make sure the wires are securely connected.

**CAUTION: Important**

Be sure to connect AC wires with correct polarity. If L and N wires are connected reversely, it may cause utility short-circuited when these inverters are worked in parallel operation.

**CAUTION:** Appliances such as air conditioner are required at least 2~3 minutes to restart because it's required to have enough time to balance refrigerant gas inside of circuits. If a power shortage occurs and recovers in a short time, it will cause damage to your connected appliances. To prevent this kind of damage, please check manufacturer of air conditioner if it's equipped with time-delay function before installation. Otherwise, this inverter/charger will trig overload fault and cut off output to protect your appliance but sometimes it still causes internal damage to the air conditioner.

## PV Connection

**CAUTION:** Before connecting to PV modules, please install **separately** a DC circuit breaker between inverter and PV modules.

**WARNING!** All wiring must be performed by a qualified personnel.

**WARNING:** Please switch off the inverter before you connect PV modules. Otherwise, it will damage the inverter.

**WARNING!** It's very important for system safety and efficient operation to use appropriate cable for PV module connection. To reduce risk of injury, please use the proper recommended cable size as below.

| Model     | Typical Amperage | Cable Size | Torque    |
|-----------|------------------|------------|-----------|
| Meta IX-6 | 27A              | 10AWG      | 2.0~2.4Nm |

### PV Module Selection:

When selecting proper PV modules, please be sure to consider below parameters:

1. Open circuit Voltage (Voc) of PV modules not exceeds max. PV array open circuit voltage of inverter.
2. Open circuit Voltage (Voc) of PV modules should be higher than min. battery voltage.

| Solar Charging Mode                |            |
|------------------------------------|------------|
| INVERTER MODEL                     | Meta IX-6  |
| Max. PV Array Open Circuit Voltage | 500 Vdc    |
| PV Array MPPT Voltage Range        | 120~430Vdc |
| MPP Number                         | 1          |

Please follow below steps to implement PV module connection:

1. Remove insulation sleeve 10 mm for positive and negative conductors.
2. Check correct polarity of connection cable from PV modules and PV input connectors. Then, connect positive pole (+) of connection cable to positive pole (+) of PV input connector. Connect negative pole (-) of connection cable

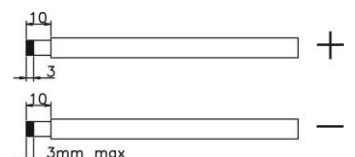

to negative pole (-) of PV input connector.

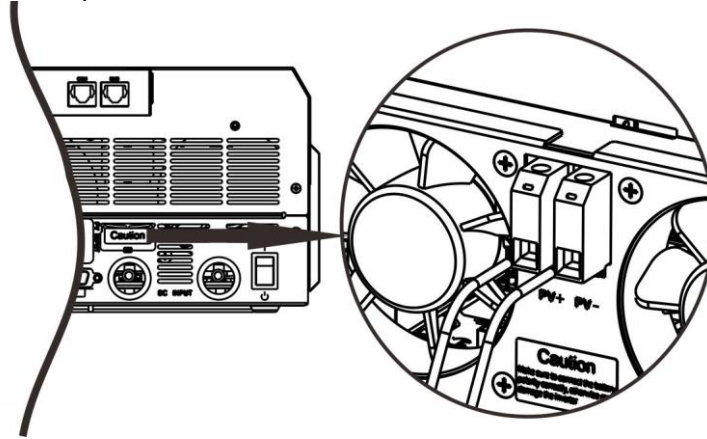

### Recommended PV module Configuration

| <b>PV Module Spec. (reference)</b><br>- 250Wp<br>- Vmp: 30.7Vdc<br>- Imp: 8.15A<br>- Voc: 37.4Vdc<br>- Isc: 8.63A<br>- Cells: 60 | Total solar input power | Solar input                                  | Q'ty of modules |
|--|-------------------------|--|-----------------|
|  | 1500W                   | 6 pieces in series                           | 6 pcs           |
|  | 2000W                   | 8 pieces in series                           | 8 pcs           |
|  | 2750W                   | 11 pieces in series                          | 11 pcs          |
|  | 3000W                   | 6 pieces in series<br>2 strings in parallel  | 12 pcs          |
|  | 4000W                   | 8 pieces in series<br>2 strings in parallel  | 16 pcs          |
|  | 5000W                   | 10 pieces in series<br>2 strings in parallel | 20 pcs          |
|  | 6000W                   | 12 pieces in series<br>2 strings in parallel | 24 pcs          |

| <b>PV Module Spec. (reference)</b><br>- 555Wp<br>- Imp: 17.32A<br>- Voc: 38.46Vdc<br>- Isc: 18.33A<br>- Cells: 110 | Total solar input power | Solar input         | Q'ty of modules |
|--|-------------------------|---------------------|-----------------|
|  | 3330W                   | 6 pieces in series  | 6 pcs           |
|  | 3885W                   | 7 pieces in series  | 7 pcs           |
|  | 4440W                   | 8 pieces in series  | 8 pcs           |
|  | 4995W                   | 9 pieces in series  | 9 pcs           |
|  | 5550W                   | 10 pieces in series | 10 pcs          |
|  | 6105W                   | 11 pieces in series | 11 pcs          |
|  | 6660W                   | 12 pieces in series | 12 pcs          |

## Final Assembly

After connecting all wirings, please put bottom cover back by screwing two screws as shown below.

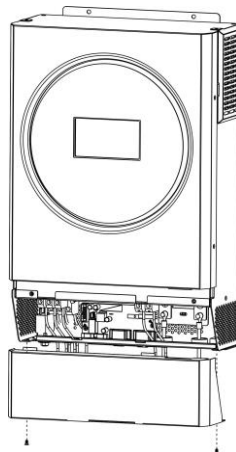

# Communication Connection

## Serial Connection

Please use supplied communication cable to connect to inverter and PC. Insert bundled CD into a computer and follow on-screen instruction to install the monitoring software. For the detailed software operation, please check user manual of software inside of CD.

## Wi-Fi Connection

Wi-Fi module can enable wireless communication between off-grid inverters and monitoring platform. Users have complete and remote monitoring and controlling experience for inverters when combining Wi-Fi module with SolarPower APP, available for both iOS and Android based device. All data loggers and parameters are saved in iCloud. For quick installation and operation, please refer to Appendix III - The Wi-Fi Operation Guide for details.

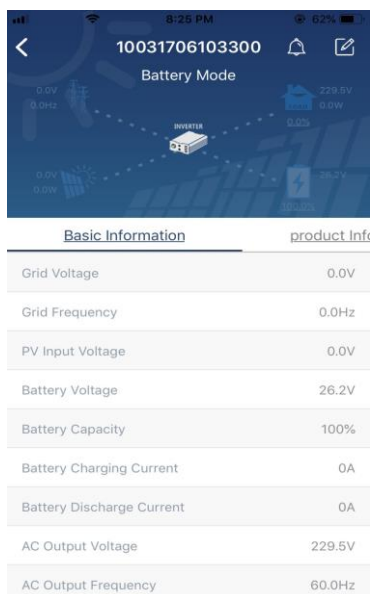

## Dry Contact Signal

There is one dry contact (3A/250VAC) available on the rear panel. It could be used to deliver signal to external device when battery voltage reaches warning level.

| Unit Status  | Condition                                |                          | Dry contact port:  |        |       |
|--|--|--------------------------|---|--------|-------|
|  |  |                          | NC & C  | NO & C |       |
| Power Off  | Unit is off and no output is powered.    |                          | Close   | Open   |       |
| Power On   | Output is powered from Utility.          |                          | Close   | Open   |       |
|  | Output is powered from Battery or Solar. | Program 01 set as SUB    | Battery voltage < Low DC warning voltage  | Open   | Close |
|  |  |                          | Battery voltage > Setting value in Program 21 or battery charging reaches floating stage                | Close  | Open  |
|  | Output is powered from Battery or Solar. | Program 01 is set as SBU | Battery voltage < Setting value in Program 20   | Open   | Close |
| Battery voltage > Setting value in Program 21 or battery charging reaches floating stage |  |                          | Close   | Open   |       |

# OPERATION

## Power ON/OFF

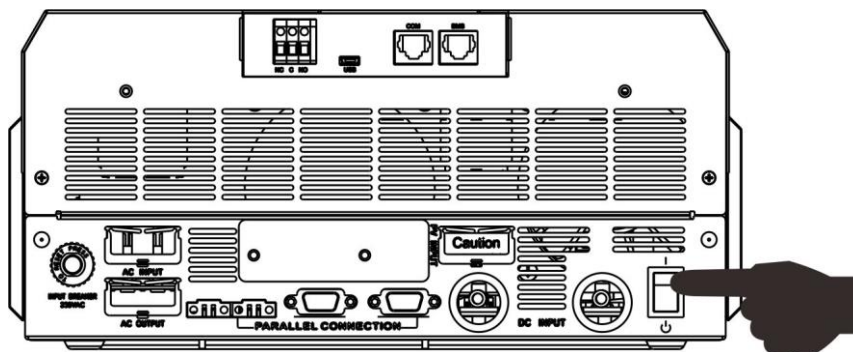

Once the unit has been properly installed and the batteries are connected well, simply press On/Off switch to turn on the unit.

## Operation and Display Panel

The operation and display panel, shown in below chart, is on the front panel of the inverter. It includes one RGB LED ring, four touchable function keys and a LCD display, indicating the operating status and input/output power information.

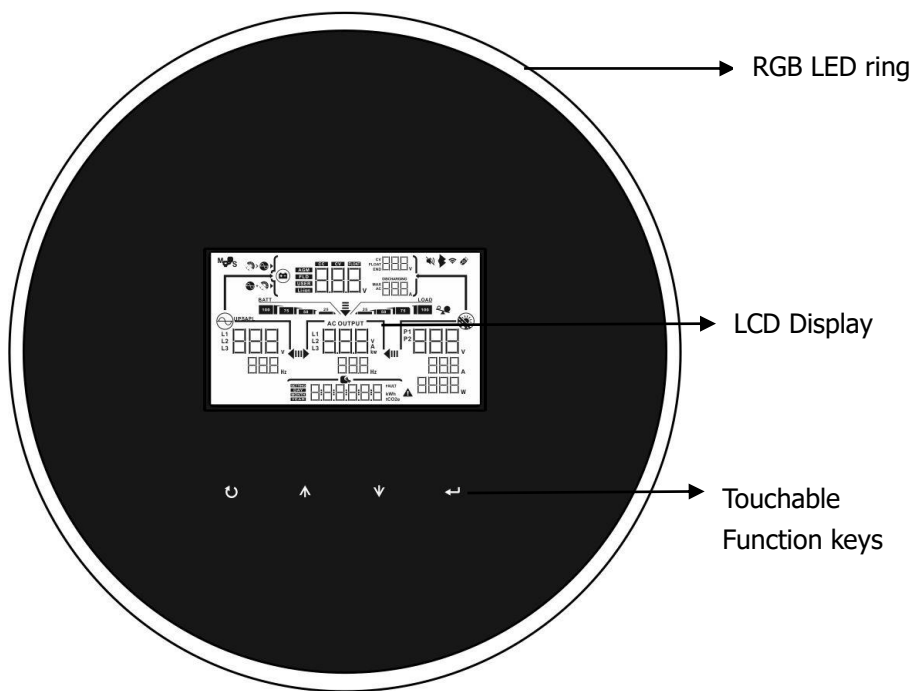

### Touchable Function Keys

| Function Key | Description           |
|--------------|-----------------------|
| ↻            | ESC                   |
|              | USB function selector |
| ▲            | Up                    |
| ▼            | Down                  |
| ↵            | Enter                 |

# LCD Display Icons

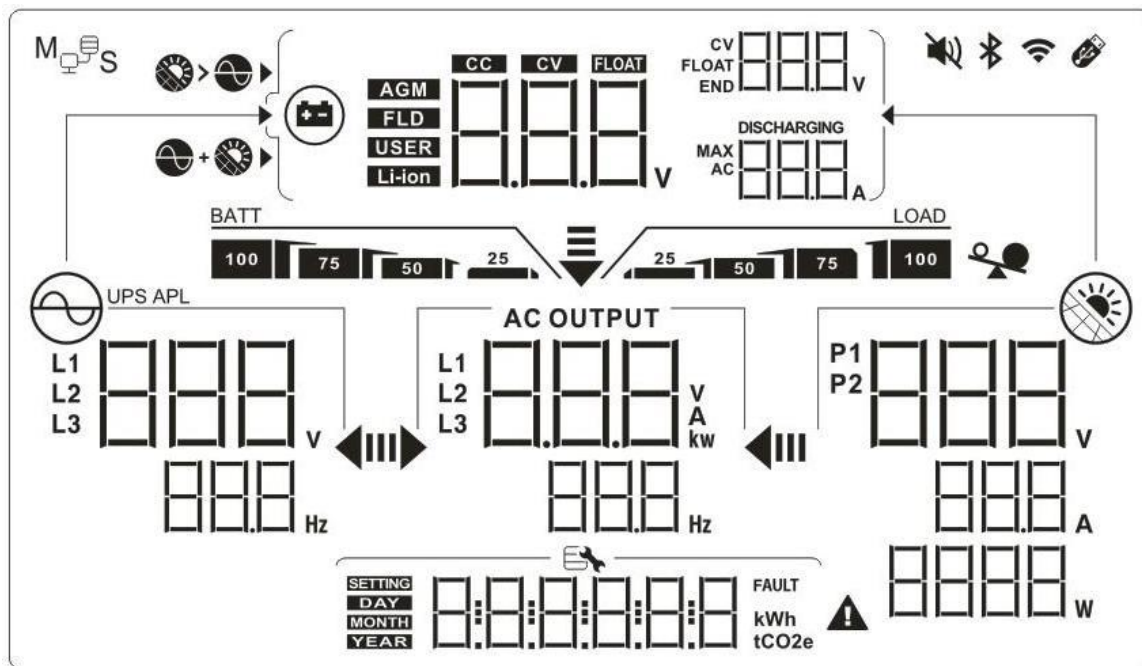

| Icon   | Function description   |
|--|--|
| <b>Input Source Information</b>                    |  |
|  | Indicates the AC input voltage and frequency.  |
|  | Indicates the PV voltage, current and power.   |
|  | Indicates the battery voltage, charging stage, configured battery parameters, charging or discharging current.       |
| <b>Configuration Program and Fault Information</b> |  |
|  | Indicates the setting programs.  |
|  | Indicates the warning and fault codes.<br>Warning:  flashing with warning code.<br>Fault:  lighting with fault code. |
| <b>Output Information</b>                          |  |

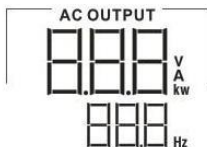
|   |   |
|---|---|
|  | Indicate the output voltage, load in VA, load in Watt and output frequency. |
|---|---|







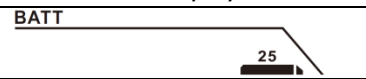

**Battery Information**

|   |  |
|---|--|
|  | Indicates battery level in battery mode and charging status in line mode by 0-24%, 25-49%, 50-74% and 75-100%. |
|---|--|



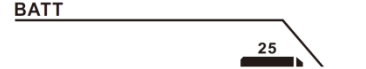



When battery is charging, it will present battery charging status.

| Status  | Battery voltage     | LCD Display   |
|---|---------------------|---|
| Constant Current mode / Constant Voltage mode | <2V/cell            | 4 bars will flash in turns.   |
|   | 2 ~ 2.083V/cell     | The right bar will be on and the other three bars will flash in turns.    |
|   | 2.083 ~ 2.167V/cell | The right two bars will be on and the other two bars will flash in turns. |
|   | > 2.167 V/cell      | The right three bars will be on and the left bar will flash.              |
| Floating mode. Batteries are fully charged.   |                     | 4 bars will be on.  |

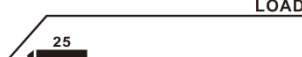

In battery mode, it will present battery capacity.





| Load Percentage | Battery Voltage           | LCD Display  |
|-----------------|---------------------------|--|
| Load >50%       | < 1.85V/cell              |    |
|                 | 1.85V/cell ~ 1.933V/cell  |    |
|                 | 1.933V/cell ~ 2.017V/cell |   |
|                 | > 2.017V/cell             |  |
| Load < 50%      | < 1.892V/cell             |  |
|                 | 1.892V/cell ~ 1.975V/cell |  |
|                 | 1.975V/cell ~ 2.058V/cell |  |
|                 | > 2.058V/cell             |  |

**Load Information**

|   |   |   |
|---|---|---|
|  | Indicates overload.   |   |
|  | Indicates the load level by 0-24%, 25-49%, 50-74% and 75-100%.                      |   |
|   | 0%~24%  | 25%~49%   |
|   |  |  |
|   | 50%~74%   | 75%~100%  |
|   |  |  |

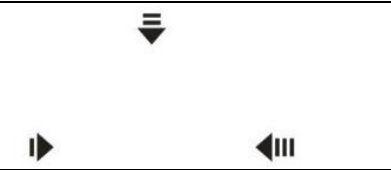

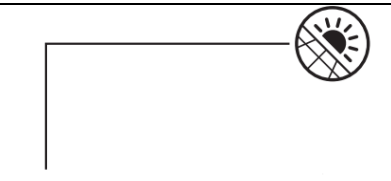
**Charger Source Priority Setting Display**

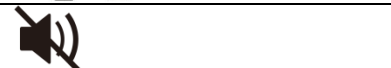
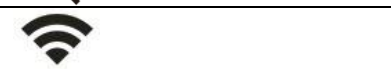
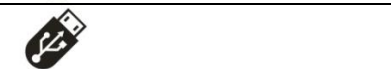
|   |  |
|---|--|
|  | Indicates setting program 10 "Charger source priority" is selected as "Solar first".       |
|  | Indicates setting program 10 "Charger source priority" is selected as "Solar and Utility". |
|  | Indicates setting program 10 "Charger source priority" is selected as "Solar only".        |





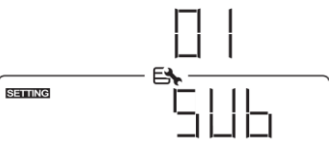
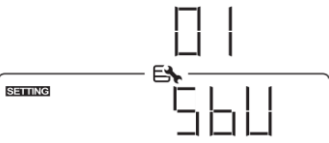
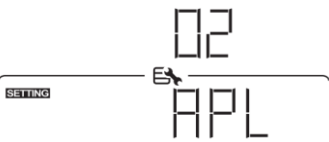

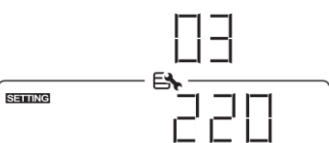
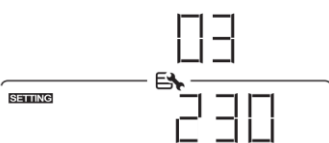
| <b>Output source priority setting display</b>                                       |   |
|---|---|
|    | Indicates setting program 01 "Output source priority" is selected as "SUB".   |
|    | Indicates setting program 01 "Output source priority" is selected as "SBU".   |
| <b>AC Input Voltage Range Setting Display</b>                                       |   |
| UPS   | Indicates setting program 02 is selected as "UPS". The acceptable AC input voltage range will be within 170-280VAC. |
| APL   | Indicates setting program 02 is selected as "APL". The acceptable AC input voltage range will be within 90-280VAC.  |
| <b>Operation Status Information</b>   |   |
|    | Indicates unit connects to the mains.   |
|   | Indicates unit connects to the PV panel.  |
| AGM<br>FLD<br>USER<br>Li-ion  | Indicates battery type.   |
|  | Indicates parallel operation is working.  |
|  | Indicates unit alarm is disabled.   |
|  | Indicates Wi-Fi transmission is working.  |
|  | Indicates USB disk is connected.  |

## LCD Setting

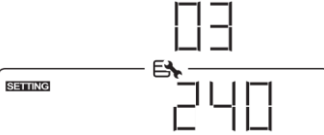
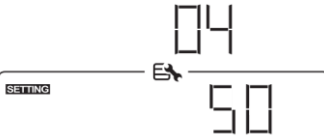

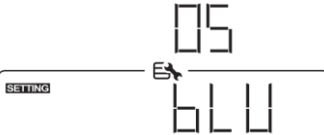
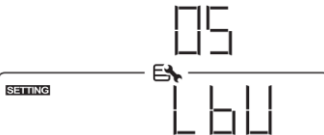
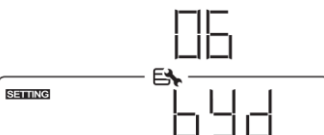
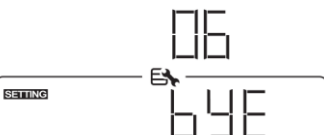
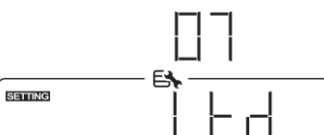
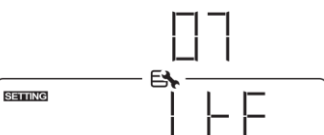
After pressing and holding ENTER button for 3 seconds, the unit will enter setting mode. Press "UP" or "DOWN" button to select setting programs. And then, press "ENTER" button to confirm the selection or ESC button to exit.



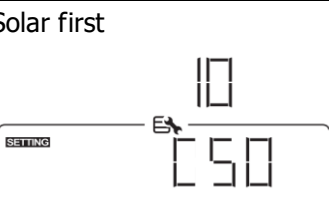
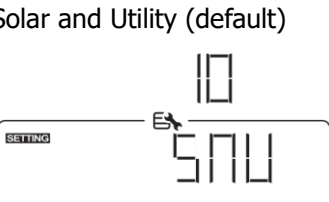
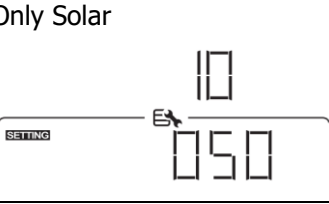
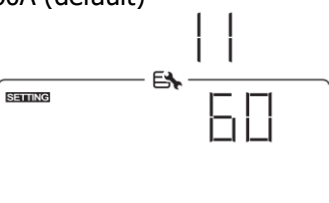
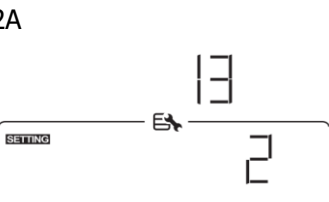
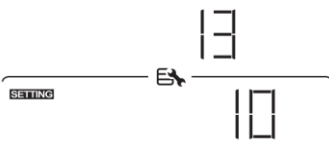
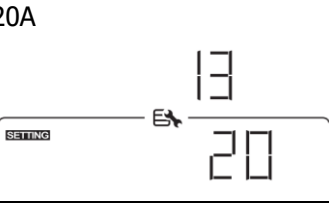
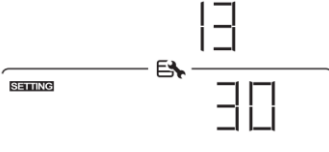
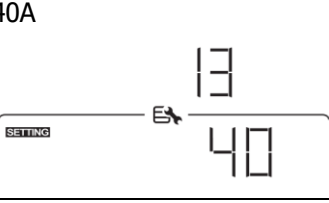
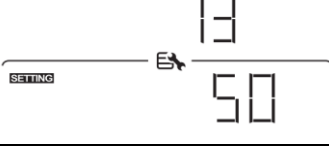
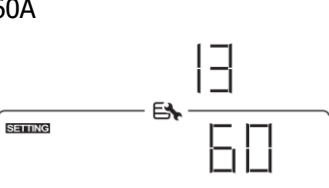
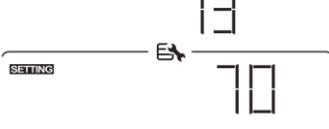

| Program | Description                      | Selectable option   |  |
|---------|----------------------------------|---|--|
| 00      | Exit setting mode                | Escape<br>                 |  |
| 01      | Output source priority selection | SUB(default)<br>           | Solar energy provides power to the loads as first priority.<br>If solar energy is not sufficient to power all connected loads, Utility energy will supply power to the loads at the same time.   |
|         |                                  | SBU<br>                   | Solar energy provides power to the loads as first priority.<br>If solar energy is not sufficient to power all connected loads, battery energy will supply power to the loads at the same time.<br>Utility provides power to the loads only when battery voltage drops to either low-level warning voltage or the setting point in program 20 or solar and battery is not sufficient. |
| 02      | AC input voltage range           | Appliances (default)<br> | If selected, acceptable AC input voltage range will be within 90-280VAC.   |
|         |                                  | UPS<br>                  | If selected, acceptable AC input voltage range will be within 170-280VAC.  |
| 03      | Output voltage                   | 220Vac<br>               | 230V (Default)<br>   |

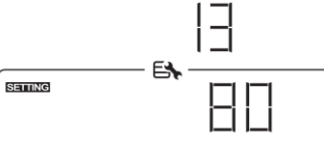
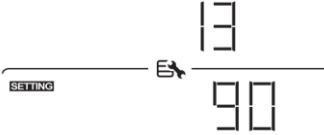
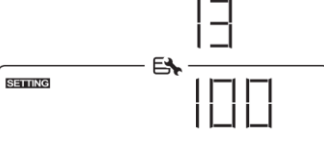
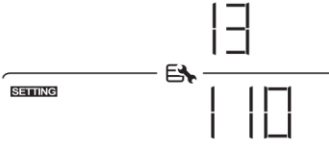
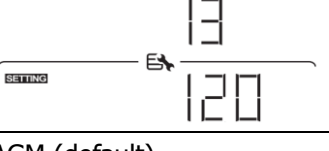

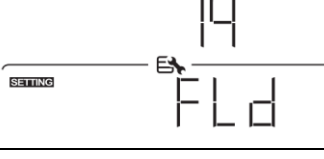
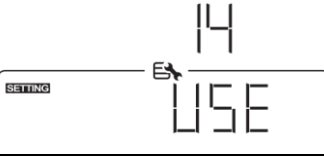
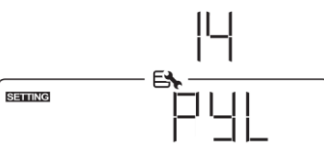
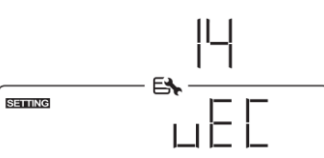
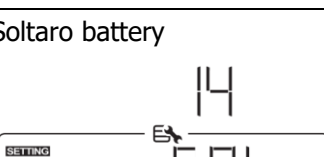
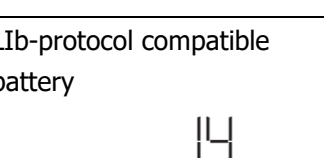

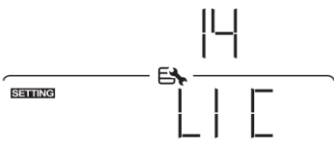
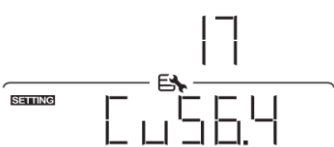
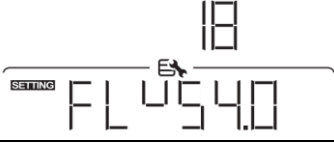

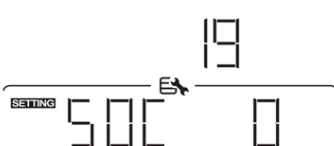
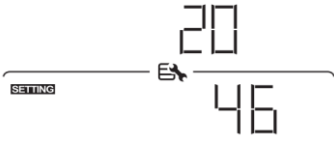

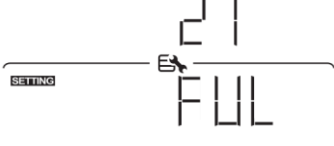
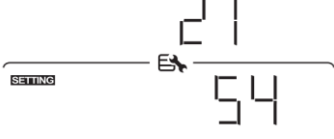

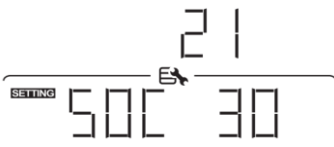
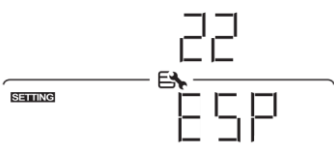
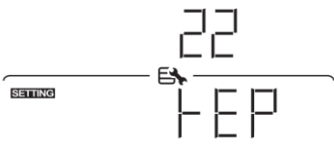
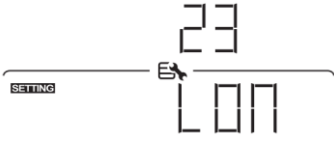
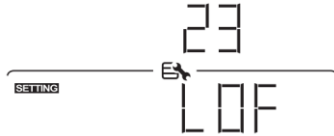
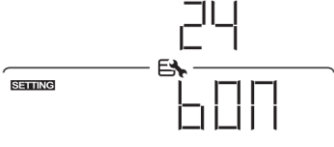
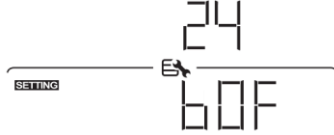
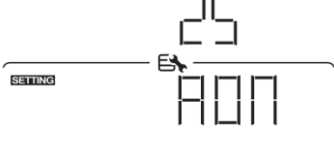
|    |   |   |  |
|----|---|---|--|
|    |   | 240Vac<br>                           |  |
| 04 | Output frequency  | 50Hz (default)<br>                   | 60Hz<br>                      |
| 05 | Solar supply priority   | Charge battery first (default)<br>   | Solar energy provides power to charge battery as first priority.   |
|    |   | Power the loads first<br>            | Solar energy provides power to the loads as first priority.  |
| 06 | Overload bypass:<br>When enabled, the unit will transfer to line mode if overload occurs in battery mode. | Bypass disable<br>                 | Bypass enable (default)<br> |
| 07 | Auto restart when overload occurs   | Restart disable (default)<br>      | Restart enable<br>          |
| 08 | Auto restart when over temperature occurs   | Restart disable (default)<br>      | Restart enable<br>          |
| 09 | Solar energy feed to grid configuration   | Feed to grid disable (default)<br> | If selected, solar energy is not allowed to feed to the grid.  |
|    |   | Feed to grid enable<br>            | If selected, solar energy is allowed to feed to the grid.  |

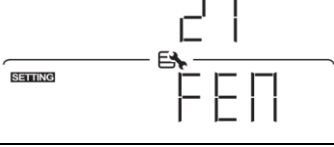
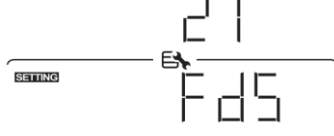
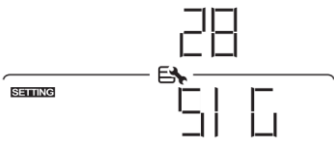
|    |   |  |   |
|----|---|--|---|
| 10 | Charger source priority:<br>To configure charger source priority  | If this inverter/charger is working in Line, Standby or Fault mode, charger source can be programmed as below:   |   |
|    |   | Solar first<br>                 | Solar energy will charge battery as first priority.<br>Utility will charge battery only when solar energy is not available. |
|    |   | Solar and Utility (default)<br> | Solar energy and utility will charge battery at the same time.  |
|    |   | Only Solar<br>                  | Solar energy will be the only charger source no matter utility is available or not.   |
| 11 | Maximum charging current:<br>To configure total charging current for solar and utility chargers.<br>(Max. charging current = utility charging current + solar charging current) | 60A (default)<br>              | The setting range is from 10A to 120A. Increment of each click is 10A.  |
| 13 | Maximum utility charging current  | 2A<br>                        | 10A<br>                                |
|    |   | 20A<br>                       | 30A (default)<br>                      |
|    |   | 40A<br>                       | 50A<br>                                |
|    |   | 60A<br>                       | 70A<br>                                |

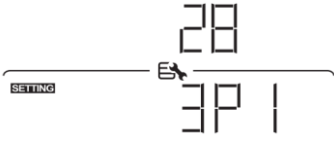

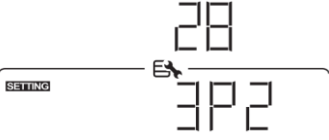
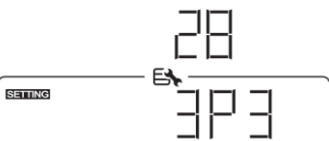
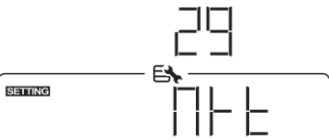
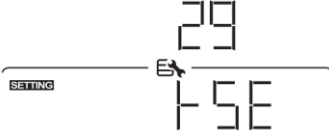

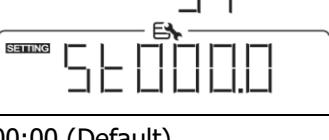
|    |              |  |   |
|----|--------------|--|---|
|    |              | <p>80A</p>                                | <p>90A</p>   |
|    |              | <p>100A</p>                               | <p>110A</p>    |
|    |              | <p>120A</p>                               |   |
| 14 | Battery type | <p>AGM (default)</p>                      | <p>Flooded</p>   |
|    |              | <p>User-Defined</p>                      | <p>If "User-Defined" is selected, battery charge voltage and low DC cut-off voltage can be set up in program 17, 18 and 19.</p>   |
|    |              | <p>Pylontech battery</p>                | <p>If selected, programs of 11, 17, 18 and 19 will be automatically set up. No need for further setting.</p>  |
|    |              | <p>WECO battery</p>                     | <p>If selected, programs of 11, 17, 18, 19 and 20 will be auto-configured per battery supplier recommended. No need for further adjustment. Programs of 20 and 21 parameters refer to SOC of battery.</p> |
|    |              | <p>Soltaro battery</p>                  | <p>If selected, programs of 11, 17, 18 and 19 will be automatically set up. No need for further setting.</p>  |
|    |              | <p>LIb-protocol compatible battery</p>  | <p>Select "LIb" if using Lithium battery compatible to Lib protocol. If selected, programs of 11, 17, 18 and 19 will be automatically set up. No need for further setting.</p>                            |

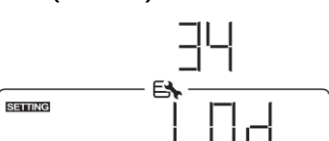
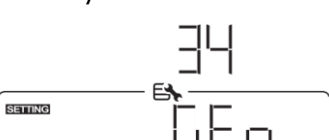
|    |   |  |   |
|----|---|--|---|
|    |   | 3 <sup>rd</sup> party Lithium battery<br> | If selected, programs of 02, 26, 27 and 29 will be automatically set up. No need for further setting. Please contact the battery supplier for installation procedure.   |
| 17 | Bulk charging voltage (C.V voltage)                     | Default setting: 56.4V<br>                | If self-defined is selected in program 14, this program can be set up. Setting range is from 48.0V to 64.0V. Increment of each click is 0.1V.   |
| 18 | Floating charging voltage                               | Default setting: 54.0V<br>                | If self-defined is selected in program 14, this program can be set up. Setting range is from 48.0V to 64.0V. Increment of each click is 0.1V.   |
| 19 | Low DC cut off battery voltage setting                  | Default setting: 40.8V<br>                | If self-defined is selected in program 14, this program can be set up. Setting range is from 40.8V to 48.0V. Increment of each click is 0.1V. Low DC cut-off voltage will be fixed to setting value no matter what percentage of load is connected. |
|    |   | SOC 0% (default)<br>                    | If any type of lithium battery is selected in program 14, this program can be set up. Setting range is from 0% to 80%   |
| 20 | Battery stop discharging voltage when grid is available | default setting: 46V<br>                | Setting range is from 44V to 51V and increment of each click is 1V.   |
|    |   | 10% (default)<br>                       | If any type of lithium battery is selected in program 14, this setting will change to SOC automatically. Adjustable range is from 5% to 95%.  |
| 21 | Battery stop charging voltage when grid is available    | Battery fully charged<br>               | The setting range is FUL and then from 48V to 58V. Increment of each click is 1V.   |
|    |   | Default setting: 54V<br>                |   |

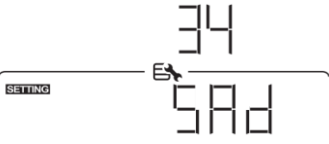
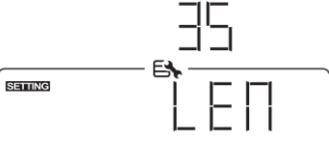
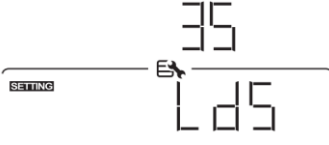
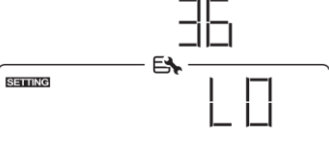
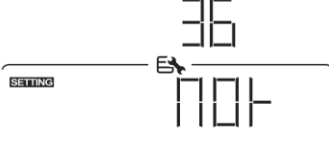
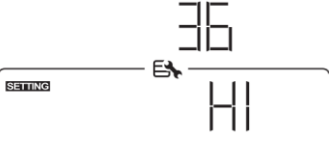
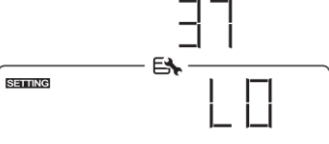
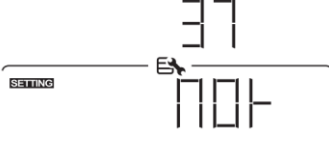
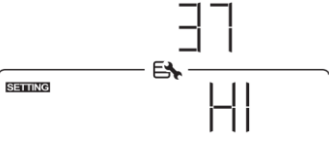
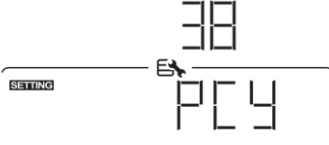
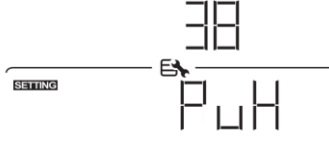
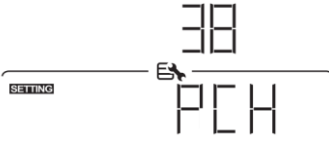
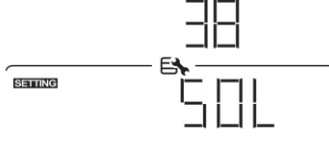
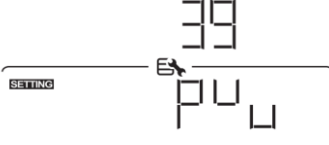

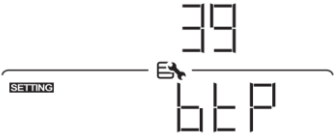
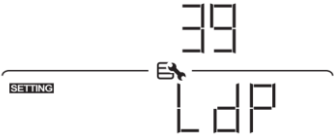
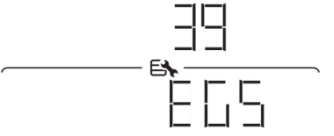
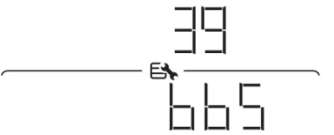
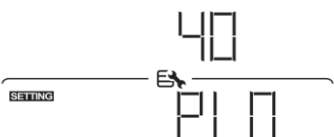
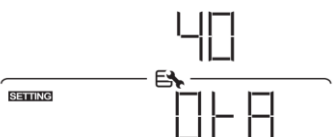

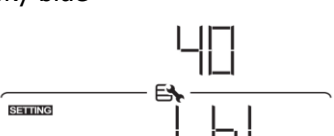

|    |  |   |   |
|----|--|---|---|
|    |  | 30% (default)<br>  | If any lithium battery is selected in program 14, this parameter will refer to the SOC of battery and adjustable from 10% to 100%. Increment of each click is 5%.                       |
| 22 | Auto return to default display screen  | Return to default display screen (default)<br>                   | If selected, no matter how users switch display screen, it will automatically return to default display screen (Input voltage /output voltage) after no button is pressed for 1 minute. |
|    |  | Stay at latest screen<br>  | If selected, the display screen will stay at latest screen user finally switches.   |
| 23 | Backlight control  | Backlight on (default)<br>                                       | Backlight off<br>   |
|    |  | Alarm on (default)<br>   | Alarm off<br>   |
| 25 | Beeps while primary source is interrupted  | Alarm on (default)<br>   | Alarm off<br>   |
|    |  | Record enable<br>  | Record disable (default)<br>  |
| 28 | AC output mode<br>*This setting is only available when the inverter is in standby mode (Switch off). | Single: This inverter is used in single phase application.<br> | Parallel: This inverter is operated in parallel system.<br>   |
|    |  | L1 phase<br>   | The inverter is operated in L1 phase in 3-phase application.  |

|    |                                    |   |   |
|----|------------------------------------|---|---|
|    |                                    | L2 phase<br>           | The inverter is operated in L2 phase in 3-phase application.  |
|    |                                    | L3 phase<br>           | The inverter is operated in L3 phase in 3-phase application.  |
| 29 | Reset PV energy storage            | Not reset(Default)<br> | Reset<br>  |
| 30 | Start charging time for AC charger | 00:00 (Default)<br>    | The setting range of start charging time for AC charger is from 00:00 to 23:00, increment of each click is 1 hour.                    |
| 31 | Stop charging time for AC charger  | 00:00 (Default)<br>  | The setting range of stop charging time for AC charger is from 00:00 to 23:00, increment of each click is 1 hour.                     |
| 32 | Scheduled time for AC output on    | 00:00 (Default)<br>  | The setting range of scheduled Time for AC output on is from 00:00 to 23:00, increment of each click is 1 hour.                       |
| 33 | Scheduled time for AC output off   | 00:00(Default)<br>   | The setting range of scheduled Time for AC output off is from 00:00 to 23:00, increment of each click is 1 hour.                      |
| 34 | Set country customized regulations | India(Default)<br>   | If selected, acceptable feed-in grid voltage range will be 195.5~253VAC. Acceptable feed-in grid frequency range will be 49~51Hz.     |
|    |                                    | Germany<br>          | If selected, acceptable feed-in grid voltage range will be 184~264.5VAC. Acceptable feed-in grid frequency range will be 47.5~51.5Hz. |
|    |                                    | South America   | If selected, acceptable feed-in grid voltage range will be 184~264.5VAC. Acceptable feed-in grid frequency range will be 57~62Hz.     |

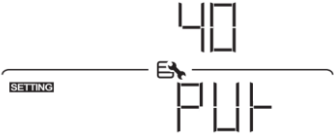
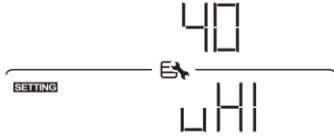
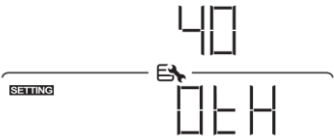

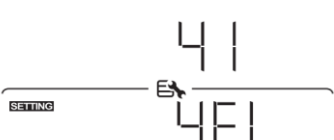
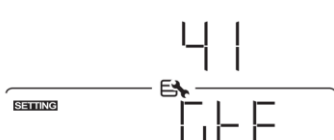
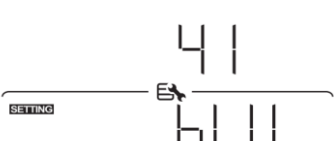
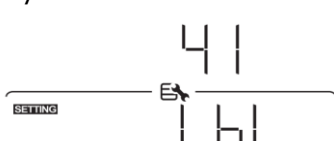
|    |   |  |  |
|----|---|--|--|
|    |   |                                 |  |
| 35 | On/Off control for RGB LED<br>*It's necessary to enable this setting to activate RGB LED lighting function. | Enabled (default)<br>           | Disable<br>   |
| 36 | Brightness of RGB LED   | Low<br>                         | Normal (default)<br>  |
|    |   | High<br>                        |  |
| 37 | Lighting speed of RGB LED   | Low<br>                        | Normal (default)<br>   |
|    |   | High<br>                      |  |
| 38 | RGB LED effect  | Power cycling<br>             | Power wheel<br>   |
|    |   | Power chasing<br>             | Solid on (Default)<br>  |
| 39 | Data Presentation of data color   | Solar input power in watt<br> | LED lighting portion will be changed by the percentage of solar input power and nominal PV power. If "Solid on" is selected in #38, LED ring will light up with background color setting in #40. If "Power wheel" is selected in #38, LED ring will light up in 4 levels. If "cycling" or "chasing" is selected in |

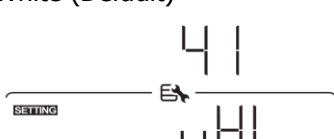

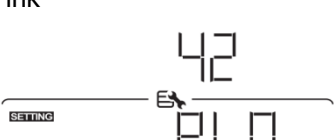
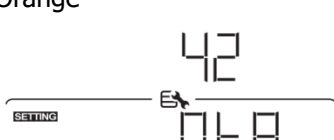
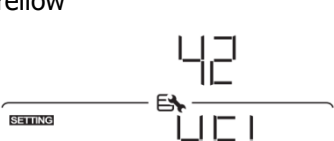
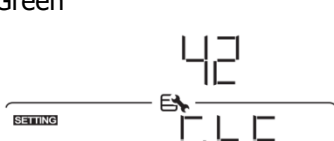
|    |  |  |  |
|----|--|--|--|
|    |  |  | #38, LED ring will light up in 12 levels.  |
| 39 | Data Presentation of data color<br>*Energy source (Grid-PV-Battery) and battery charge/discharge status only available when RGB LED effect is set to "Solid on". | Battery capacity percentage (Default)<br> | LED lighting portion will be changed by battery capacity percentage.<br>If "Solid on" is selected in #38, LED ring will light up with background color setting in #40.<br>If "Power wheel" is selected in #38, LED ring will light up in 4 levels.<br>If "cycling" or "chasing" is selected in #38, LED ring will light up in 12 levels. |
|    |  | Load percentage.<br>                      | LED lighting portion will be changed by load percentage.<br>If "Solid on" is selected in #38, LED ring will light up with background color setting in #40.<br>If "Power wheel" is selected in #38, LED ring will light up in 4 levels.<br>If "cycling" or "chasing" is selected in #38, LED ring will light up in 12 levels.             |
|    |  | Energy source (Grid-PV-Battery)<br>      | If selected, the LED color will be background color setting in #40 in AC mode. If PV power is active, the LED color will be data color setting in #41. If the remaining status, the LED color will be set in #42.  |
|    |  | Battery charge/discharge status<br>     | If selected, the LED color will be background color setting in #40 in battery charging status. The LED color will be data color setting in #41 in battery discharging status.  |
| 40 | Background color of RGB LED  | Pink<br>                                | Orange<br>  |
|    |  | Yellow<br>                              | Green<br>   |
|    |  | Blue<br>                                | Sky blue<br>  |

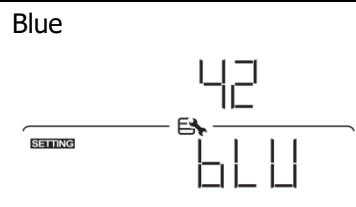
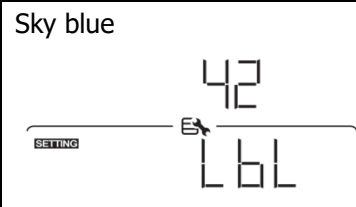
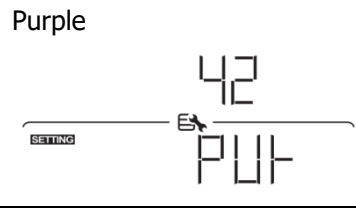
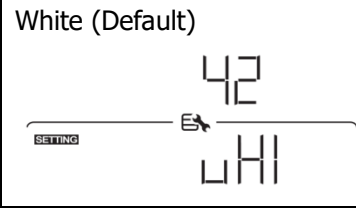
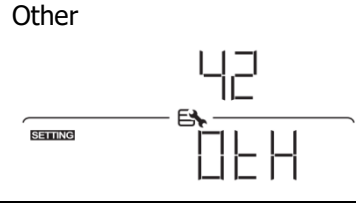
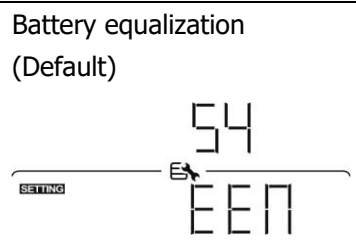
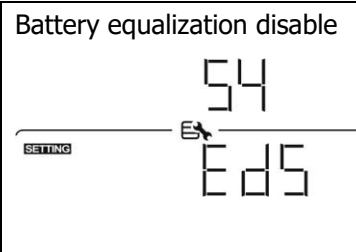
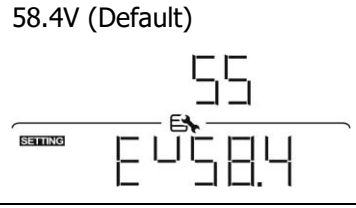
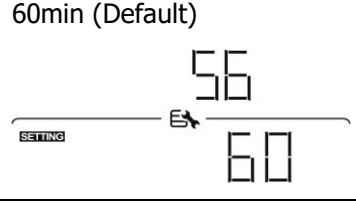
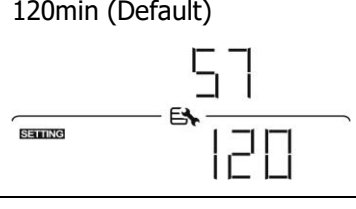
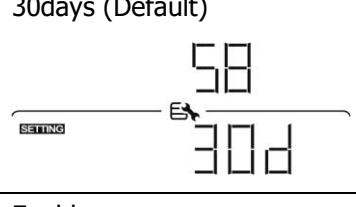
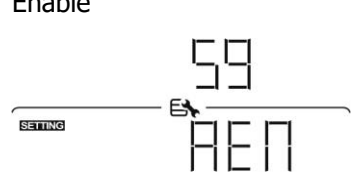
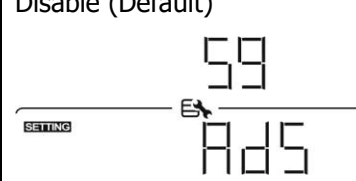

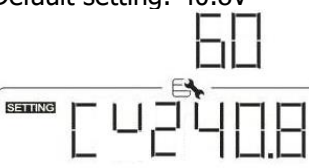
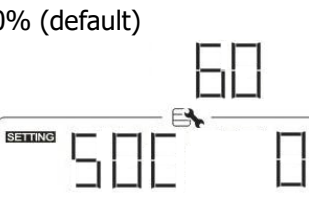
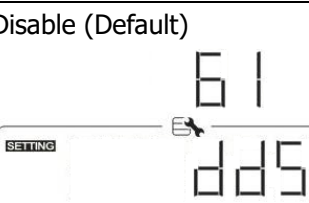
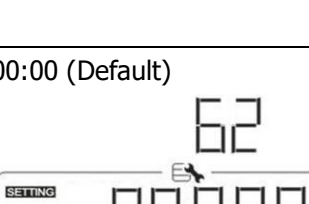
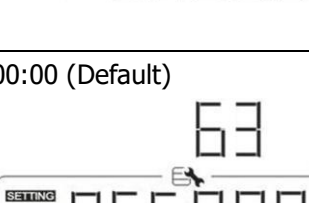
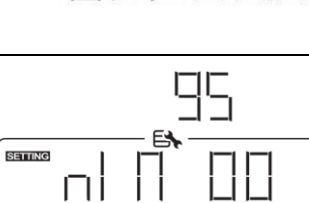
|    |  |   |  |
|----|--|---|--|
| 40 | Background color of RGB LED  | Purple<br>   | White (Default)<br>   |
|    |  | Other<br>    | If "other" is selected, the background color is set by RGB via software.                                 |
| 41 | Data Color for RGB LED   | Pink<br>     | Orange<br>            |
|    |  | Yellow<br>   | Green<br>             |
|    |  | Blue<br>   | Sky blue<br>        |
|    |  | Purple<br> | White (Default)<br> |
|    |  | Other<br>  | If "other" is selected, the data color is set by RGB via software.                                       |
| 42 | Background color of RGB LED only available when data Presentation of data color is set to Energy source (Grid-PV-Battery). | Pink<br>   | Orange<br>          |
|    |  | Yellow<br> | Green<br>           |

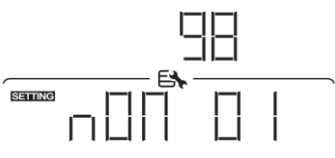

|    |  |  |   |
|----|--|--|---|
| 42 | Background color of RGB LED only available when data Presentation of data color is set to Energy source (Grid-PV-Battery). | Blue<br>                            | Sky blue<br>                      |
|    |  | Purple<br>                          | White (Default)<br>               |
|    |  | Other<br>                           | If "other" is selected, the background color is set by RGB via software.  |
| 54 | Battery equalization   | If "Flooded" or "User-Defined" is selected in program 05, this program can be set up.                                |   |
|    |  | Battery equalization (Default)<br> | Battery equalization disable<br> |
| 55 | Battery equalization voltage   | 58.4V (Default)<br>               | Setting range is from 48V to 64V. Increment of each click is 0.1V.  |
| 56 | Battery equalized time   | 60min (Default)<br>               | Setting range is from 5min to 900min. Increment of each click is 5min.  |
| 57 | Battery equalized timeout  | 120min (Default)<br>              | Setting range is from 5min to 900 min. Increment of each click is 5 min.  |
| 58 | Equalization interval  | 30days (Default)<br>              | Setting range is from 0 to 90 days. Increment of each click is 1 day  |
| 59 | Equalization activated immediately   | Enable<br>                        | Disable (Default)<br>           |

|    |  |   |   |
|----|--|---|---|
|    |  | <p>If equalization function is enabled in program 33, this program can be set up. If "Enable" is selected in this program, it's to activate battery equalization immediately and LCD main page will shows "E Q". If "Disable" is selected, it will cancel equalization function until next activated equalization time arrives based on program 37 setting. At this time, "E Q" will not be shown in LCD main page.</p> |   |
| 60 | Low DC cut off voltage on second output  | <p>Default setting: 40.8V</p>    | <p>Setting range is from 40.8V to 48.0V.<br/>Increment of each click is 0.1V.<br/>This low DC cut-off voltage will be fixed to setting value no matter what percentage of load is connected.</p>  |
|    |  | <p>0% (default)</p>    | <p>If any type of lithium battery is selected in program 14, this parameter value will be displayed in percentage and value setting is based on battery capacity percentage. Setting range is from 0% to 95%. Increment of each click is 5%.</p>          |
| 61 | Setting discharge time on the 2nd output | <p>Disable (Default)</p>   | <p>Setting range is disable and then from 0 min to 990 min. Increment of each click is 5 min.<br/>*If the battery discharge time achieves the setting time in program 61 and the program 60 function is not triggered, the output will be turned off.</p> |
| 62 | Scheduled time for 2nd AC output on      | <p>00:00 (Default)</p>   | <p>Setting range is from 00:00 to 23:00.<br/>Increment of each click is 1 hour.<br/>Within scheduled on/off time setting in program 62 and 63, 2nd AC output will be turn off based on the setting value in program 60 or 61.</p>                         |
| 63 | Scheduled time for 2nd AC output off     | <p>00:00 (Default)</p>   | <p>Setting range is from 00:00 to 23:00.<br/>Increment of each click is 1 hour.<br/>Within scheduled on/off time setting in program 62 and 63, 2nd AC output will be turn off based on the setting value in program 60 or 61.</p>                         |
| 95 | Time setting – Minute                    |    | <p>For minute setting, the range is from 00 to 59.</p>  |
| 96 | Time setting – Hour                      |    | <p>For hour setting, the range is from 00 to 23.</p>  |
| 97 | Time setting– Day                        |    | <p>For day setting, the range is from 00 to 31.</p>   |

|    |                     |   |  |
|----|---------------------|---|--|
| 98 | Time setting– Month |  | For month setting, the range is from 01 to 12. |
| 99 | Time setting – Year |  | For year setting, the range is from 16 to 99.  |

## USB Function Setting

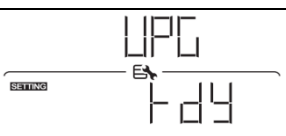
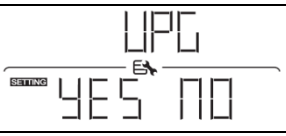
Follow below steps to upgrade firmware.

| Procedure  | LCD Screen   |
|--|--|
| <b>Step 1:</b> Insert an USB disk into the USB port (13 in product overview). Press and hold "↻" button for 3 seconds to enter USB Function Setting Mode. It will show "🔌" on the top right corner and "fdy" in LCD.   |   |
| <b>Step 2:</b> Press "←" button to read the file from the USB disk. If there is no burning file, the LCD will alert "U01". Otherwise it will enter the next step.  |  |
| <b>Step 3:</b> <ul style="list-style-type: none"> <li>● Press "▲" button choose "yes" to start the firmware upgrade.</li> <li>● Or press "↻" or "▼" button to return to main screen.</li> </ul>  |   |
| <b>Step 4:</b> If "yes" is select, it will start the firmware upgrade. The LCD will display "YES" and complete progress in percentage on the right. "88" represents 88% completion progress. Once 100% is complete, press "↻" button to return to main screen. |  |

If no button is pressed for 1 minute, it will automatically return to main screen.

### Error message for USB On-the-Go functions:

| Error Code | Messages  |
|------------|---|
| U01        | No USB disk is detected.                        |
| U02        | USB disk is protected from copy.                |
| U03        | Document inside the USB disk with wrong format. |

If any error occurs, error code will only show 3 seconds. After 3 seconds, it will automatically return to display screen.

# Display Setting

The LCD display information will be switched in turns by pressing "▲" or "▼" key. The selectable information is switched as the following table in order.

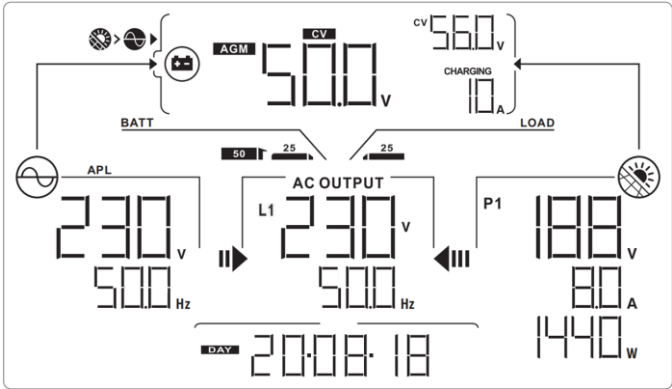
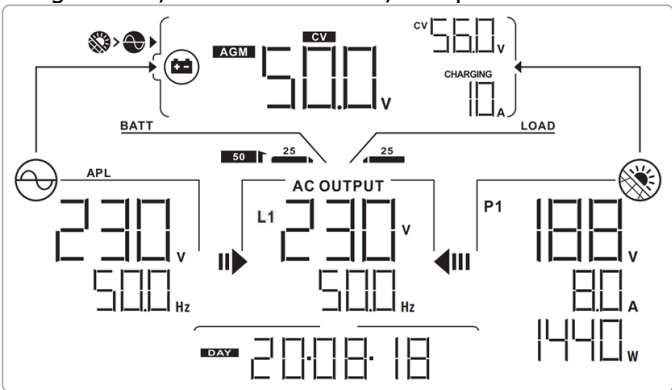
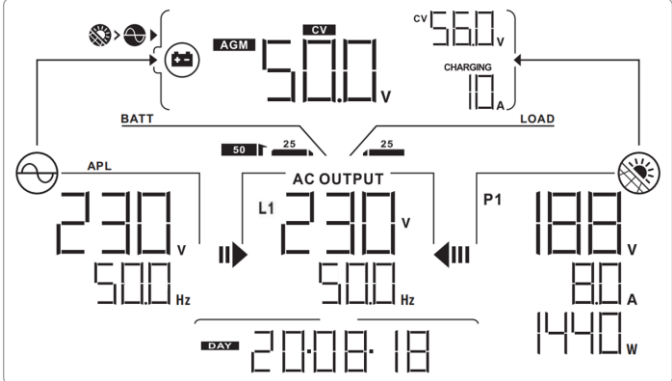
| Selectable information  | LCD display  |
|---|--|
| Utility voltage/ Utility frequency  | <p>Input Voltage=230V, Input frequency=50Hz</p>                                    |
| Default Display Screen  | <p>PV1 voltage=180V, PV1 current=8.0A, PV1 power=1440W</p>                        |
| Battery voltage, charging stage/ Configured battery parameters/ Charging or discharging current | <p>Battery voltage=50.0V, Bulk charging voltage=56.0V, Charging current=10A</p>  |

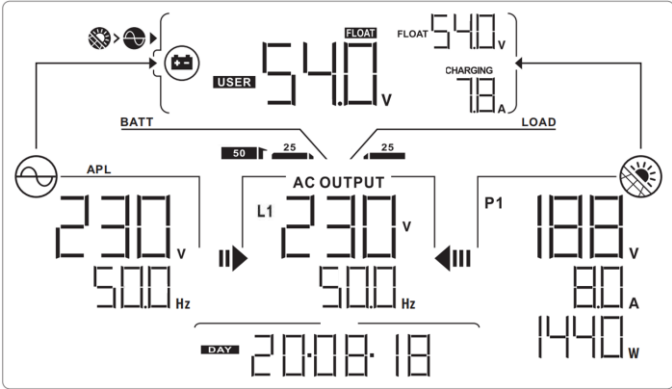
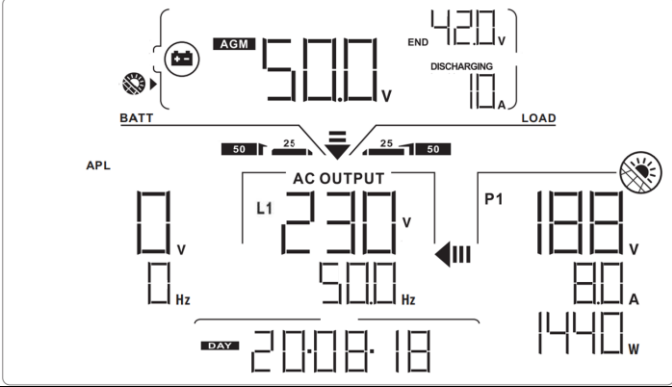
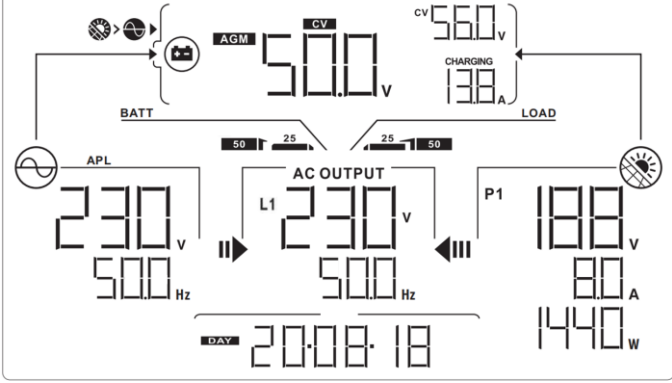
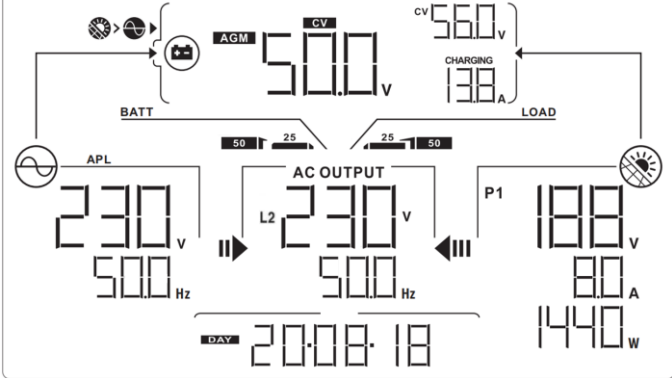
| Selectable information   | LCD display   |   |
|--|---|---|
| Default Display Screen   | <p>Battery voltage, charging stage/<br/>Configured battery parameters/<br/>Charging or discharging current</p>  | <p>Battery voltage=54.0V, Floating charging voltage=54.0V, Charging current=7.8A</p>  |
|  | <p>Battery voltage=50.0V, Low DC cut-off voltage=42.0V, Discharging current=10A</p>  |   |
| L1 output voltage/output frequency, L2 output voltage/output frequency, load in VA, load in Watt switch every 5 second | <p>L1 output voltage=230V, L1 output frequency=50Hz</p>   | <p>L1 output voltage=230V, L1 output frequency=50Hz</p>                             |
|  | <p>L2 output voltage=230V, L2 output frequency=50Hz</p>   | <p>L2 output voltage=230V, L2 output frequency=50Hz</p>                             |

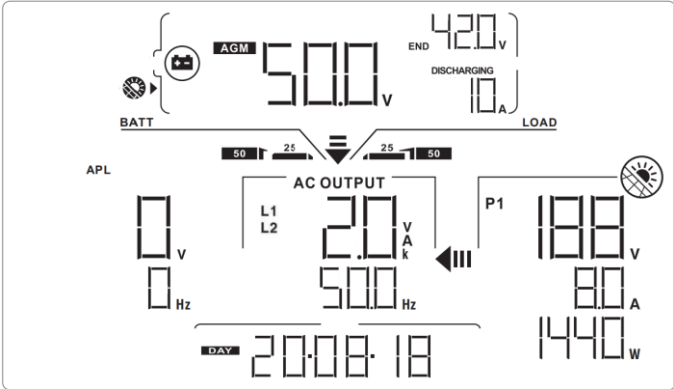
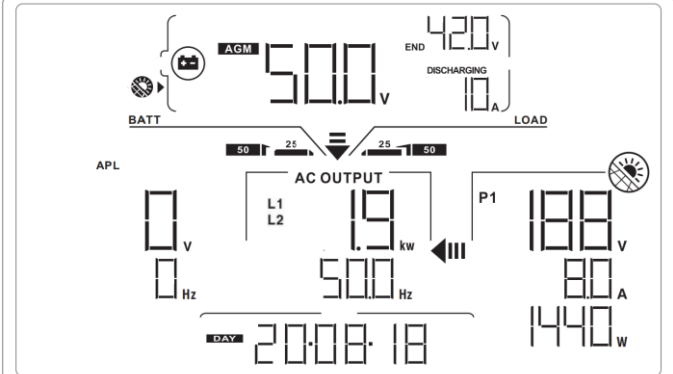
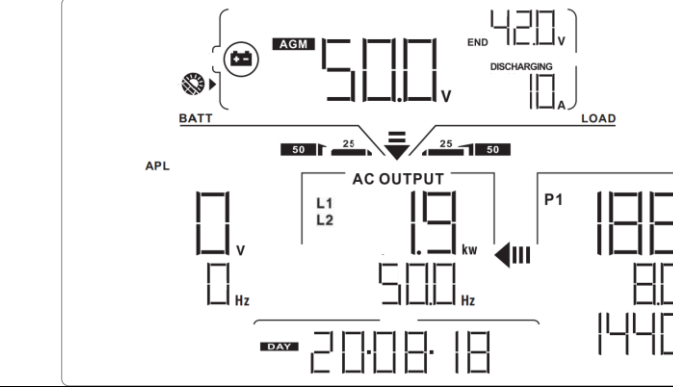
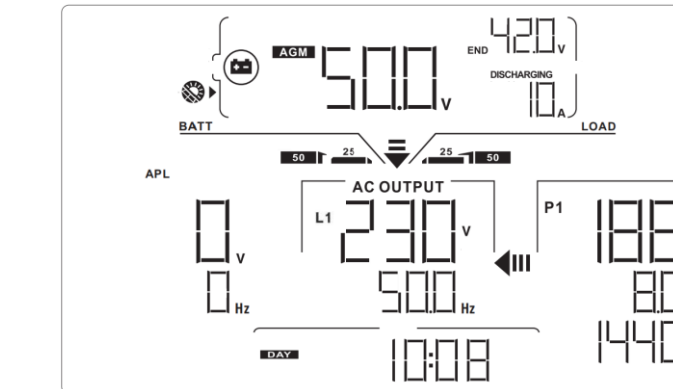
| Selectable information  | LCD display   |
|---|---|
| <p>Default Display Screen</p> <p>L1 output voltage/output frequency, L2 output voltage/output frequency, load in VA, load in Watt switch every 5 second</p> | <p>Total load in VA=2.0KVA, L1 output frequency=50Hz</p>    |
|   | <p>Total load in Watt=1.9KW, L1 output frequency=50Hz</p>  |
| <p>Real date.</p>   | <p>Real date 2020-08-18.</p>                              |
| <p>Real time.</p>   | <p>Real time 10:08.</p>                                   |

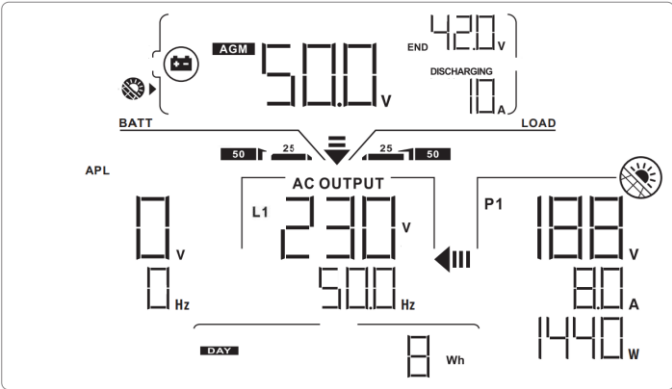
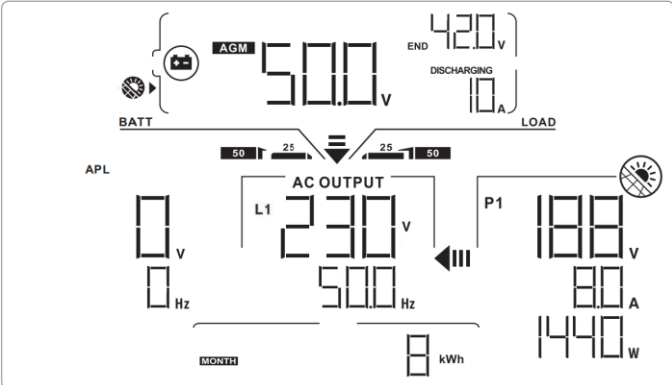
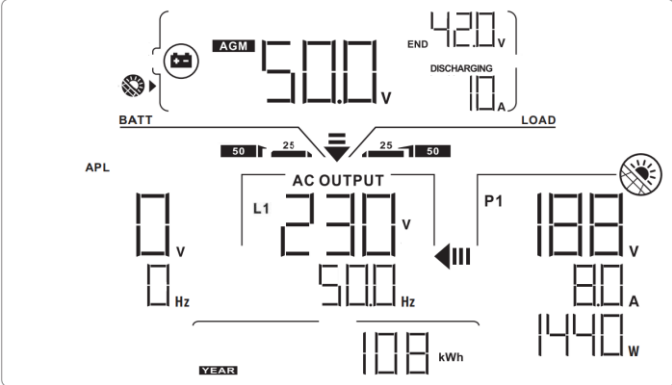
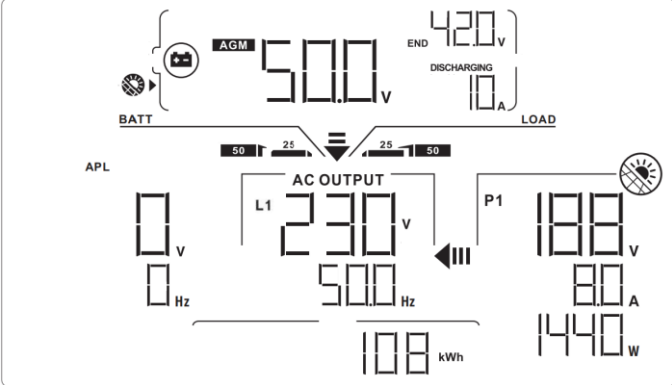
| Selectable information         | LCD display   |
|--------------------------------|---|
| PV energy generated today      | <p>PV energy generated today = 8Wh.</p>           |
| PV energy generated this month | <p>PV energy generated this month = 8kWh.</p>    |
| PV energy generated this year  | <p>PV energy generated this year = 108kWh,</p>  |
| Total PV energy generation     | <p>Total PV energy generation = 108kWh.</p>     |



| Selectable information          | LCD display                            |
|---------------------------------|--|
| Main CPU version checking.      | <p>Main CPU version 00050.72.</p>      |
| Secondary CPU version checking. | <p>Secondary CPU version 00022.01.</p> |

## Operating Mode Description

| Operating mode   | Behaviors   | LCD display                             |
|--|---|---|
| Standby mode<br><b>Note:</b><br>*Standby mode: The inverter is not turned on yet but at this time, the inverter can charge battery without AC output.<br>*Power saving mode: If enabled, the output of inverter will be off when connected load is pretty low or not detected. | No output power, solar or utility charger available | <p>Battery is charged by utility.</p>   |
|  |   | <p>Battery is charged by PV energy.</p> |

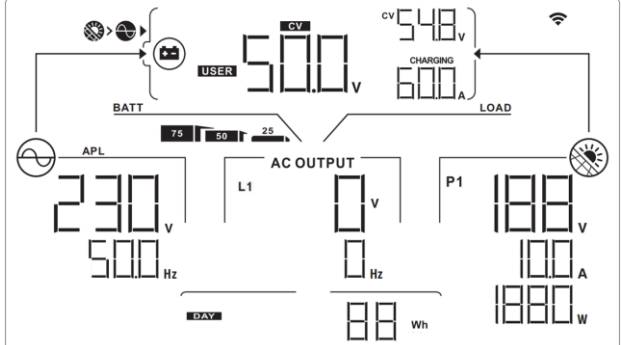
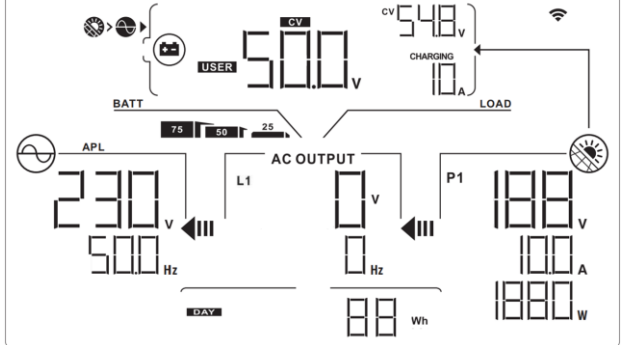
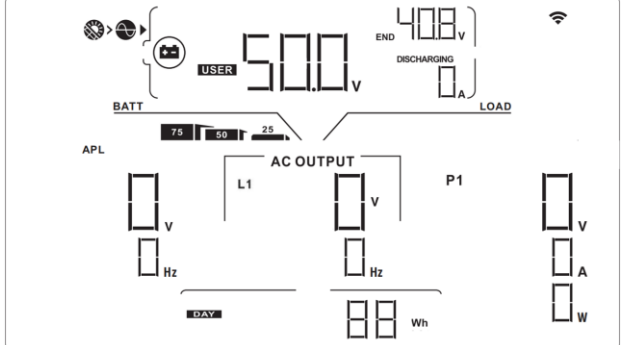
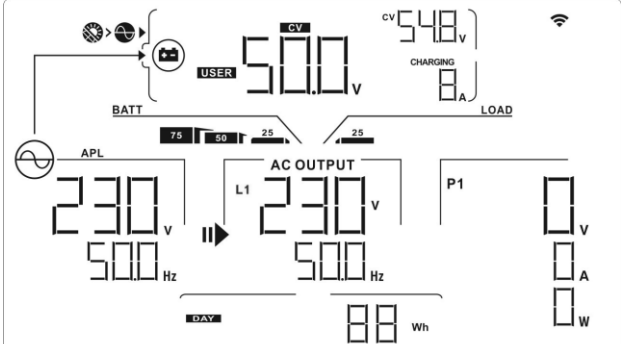
|   |  |   |
|---|--|---|
| <p>Standby mode</p> <p><b>Note:</b></p> <p>*Standby mode: The inverter is not turned on yet but at this time, the inverter can charge battery without AC output.</p> <p>*Power saving mode: If enabled, the output of inverter will be off when connected load is pretty low or not detected.</p> | <p>No output power, solar or utility charger available</p> | <p>Battery is charged by utility and PV energy.</p>  <p>The display shows a battery icon with a plus sign, indicating charging. The 'USER' voltage is 500.0 V. The 'CV' (CV) voltage is 54.8 V. The 'CHARGING' current is 600 A. The 'LOAD' is 0 A. The 'APL' (APL) voltage is 230 V and frequency is 50.0 Hz. The 'AC OUTPUT' (L1) voltage is 0 V and frequency is 0 Hz. The 'P1' (P1) voltage is 188 V, current is 100 A, and power is 1880 W. The 'DAY' (DAY) shows 88 Wh.</p>               |
|   |  | <p>Battery is charged by PV energy and feed PV energy to grid.</p>  <p>The display shows a battery icon with a plus sign, indicating charging. The 'USER' voltage is 500.0 V. The 'CV' (CV) voltage is 54.8 V. The 'CHARGING' current is 10 A. The 'LOAD' is 0 A. The 'APL' (APL) voltage is 230 V and frequency is 50.0 Hz. The 'AC OUTPUT' (L1) voltage is 0 V and frequency is 0 Hz. The 'P1' (P1) voltage is 188 V, current is 100 A, and power is 1880 W. The 'DAY' (DAY) shows 88 Wh.</p> |
|   |  | <p>No charging.</p>  <p>The display shows a battery icon with a minus sign, indicating discharging. The 'USER' voltage is 500.0 V. The 'END' (END) voltage is 40.8 V. The 'DISCHARGING' current is 0 A. The 'LOAD' is 0 A. The 'APL' (APL) voltage is 0 V and frequency is 0 Hz. The 'AC OUTPUT' (L1) voltage is 0 V and frequency is 0 Hz. The 'P1' (P1) voltage is 0 V, current is 0 A, and power is 0 W. The 'DAY' (DAY) shows 88 Wh.</p>   |
| <p>Line mode</p>  | <p>Output power from utility. Charger is available</p>     | <p>Utility charges battery and provides power to load.</p>  <p>The display shows a battery icon with a plus sign, indicating charging. The 'USER' voltage is 500.0 V. The 'CV' (CV) voltage is 54.8 V. The 'CHARGING' current is 8 A. The 'LOAD' is 25 A. The 'APL' (APL) voltage is 230 V and frequency is 50.0 Hz. The 'AC OUTPUT' (L1) voltage is 230 V and frequency is 50.0 Hz. The 'P1' (P1) voltage is 0 V, current is 0 A, and power is 0 W. The 'DAY' (DAY) shows 88 Wh.</p>         |

Line Mode

Output power from utility. Charger is available

PV energy, battery power and utility provide power to load.

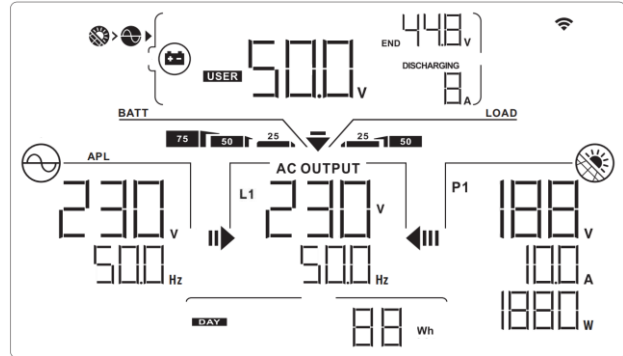

PV energy and utility charge battery, and utility provides power to load.

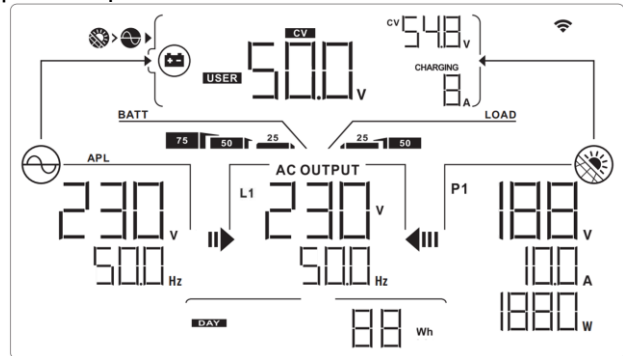

PV energy charges battery, utility and PV energy provide power to the load.

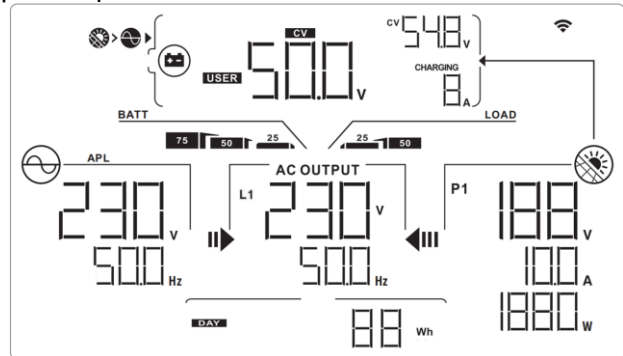



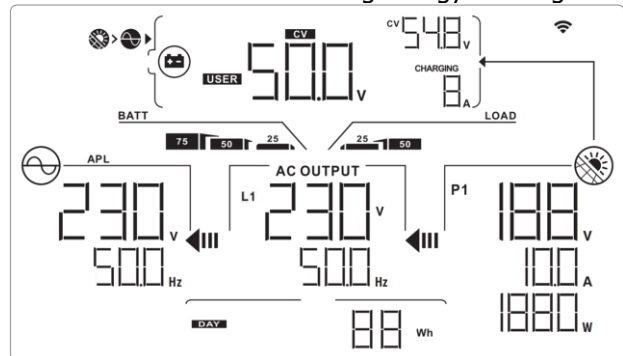

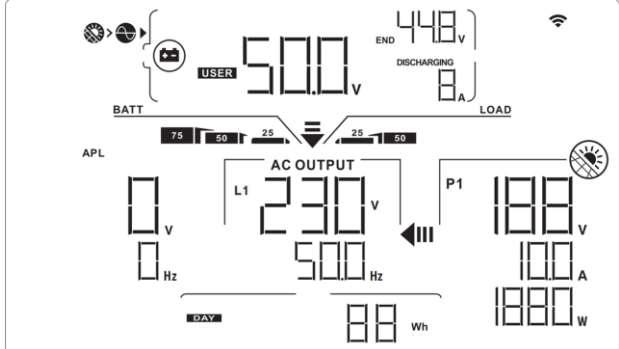
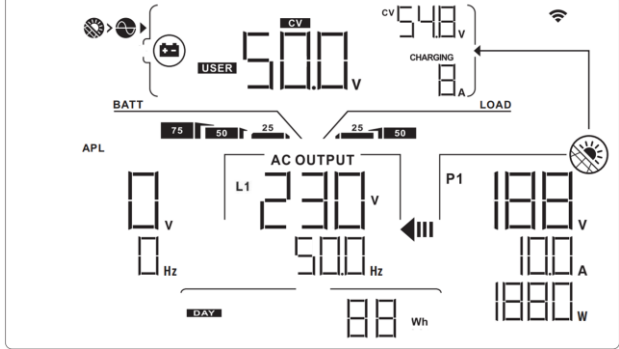
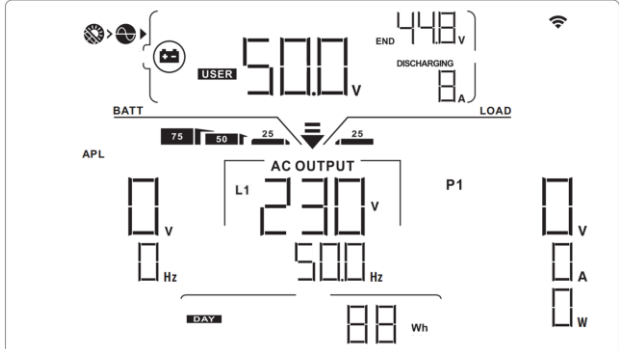
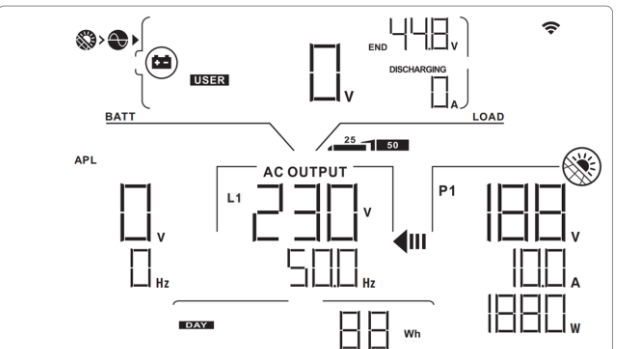

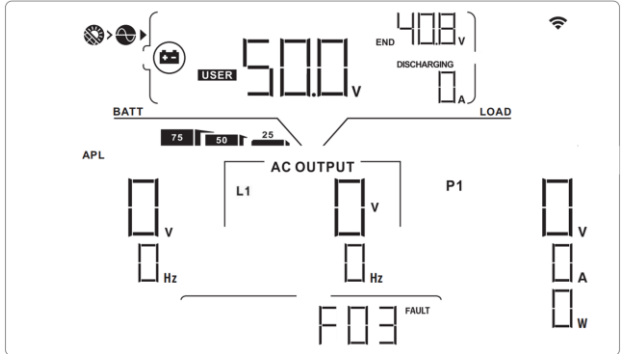

PV energy charges battery, PV energy provides power to the load and feeds remaining energy to the grid.



|                     |  |   |
|---------------------|--|---|
|                     |  | <p>PV energy and battery energy supply power to the load.</p>  <p>The display shows a battery level of 75% and a PV charging current of 8A. The AC output is 230V at 500Hz. The load is connected to P1, showing 188V, 100A, and 1880W. The battery is discharging at 8A. The user voltage is 500V. The display also shows 448V for the PV input and 88Wh for the day's energy.</p> |
| <p>Battery mode</p> | <p>Output power from battery or PV</p> | <p>PV energy charges battery and provides power to the load.</p>  <p>The display shows a battery level of 75% and a PV charging current of 8A. The AC output is 230V at 500Hz. The load is connected to P1, showing 188V, 100A, and 1880W. The battery is charging at 8A. The user voltage is 500V. The display also shows 548V for the PV input and 88Wh for the day's energy.</p> |
|                     |  | <p>Battery provides power to the load.</p>  <p>The display shows a battery level of 75% and a discharging current of 8A. The AC output is 230V at 500Hz. The load is connected to P1, showing 0V, 0A, and 0W. The user voltage is 500V. The display also shows 448V for the PV input and 88Wh for the day's energy.</p>  |
| <p>Only PV mode</p> | <p>Output power from PV</p>            | <p>PV provides power to the load.</p>  <p>The display shows a battery level of 75% and a discharging current of 8A. The AC output is 230V at 500Hz. The load is connected to P1, showing 188V, 100A, and 1880W. The user voltage is 500V. The display also shows 448V for the PV input and 88Wh for the day's energy.</p>   |

|   |                                |  |
|---|--------------------------------|--|
| <p>Fault mode</p> <p><b>Note:</b></p> <p>*Fault mode: Errors are caused by inside circuit error or external reasons such as over temperature, output short circuited and so on.</p> | <p>No output, no charging.</p> | <p>No charging.</p>  |
|---|--------------------------------|--|

## Warning Indicator

| Warning Code | Warning Event  | Icon flashing   |
|--------------|--|---|
| 01           | Fan locked   | 01   |
| 02           | Over temperature                                       | 02   |
| 03           | Battery over charged                                   | 03   |
| 04           | Low battery  | 04    |
| 07           | Overload   | 07 <br> |
| 10           | Inverter power derating                                | 10   |
| bP           | Battery is not connected                               | bP   |
| 32           | Communication lost between com. port and control board | 32   |

## Faults Reference Code

| Fault Code | Fault Event                  | Icon on |
|------------|------------------------------|---------|
| 01         | Fan is locked.               | F01     |
| 02         | Over temperature             | F02     |
| 03         | Battery voltage is too high. | F03     |
| 05         | Output is short circuited.   | F05     |
| 06         | Output voltage is abnormal.  | F06     |
| 07         | Overload time out.           | F07     |
| 08         | Bus voltage is too high.     | F08     |
| 09         | Bus soft start failure.      | F09     |
| 10         | PV current is over.          | F10     |
| 11         | PV voltage is over.          | F11     |
| 12         | Charge current is over.      | F12     |
| 51         | Over current or surge        | F51     |
| 52         | Bus voltage is too low.      | F52     |
| 53         | Inverter soft start failure. | F53     |
| 55         | Over DC offset in AC output  | F55     |
| 57         | Current sensor failure.      | F57     |
| 58         | Output voltage is too low.   | F58     |

# BATTERY EQUALIZATION

Equalization function is added into charge controller. It reverses the buildup of negative chemical effects like stratification, a condition where acid concentration is greater at the bottom of the battery than at the top. Equalization also helps to remove sulfate crystals that might have built up on the plates. If left unchecked, this condition, called sulfation, will reduce the overall capacity of the battery. Therefore, it's recommended to equalize battery periodically.

## ● How to Apply Equalization Function

You must enable battery equalization function in monitoring LCD setting program 54 first. Then, you may apply this function in device by either one of following methods:

1. Setting equalization interval in program 58.
2. Active equalization immediately in program 59.

## ● When to Equalize

In float stage, when the setting equalization interval (battery equalization cycle) is arrived, or equalization is active immediately, the controller will start to enter Equalize stage.

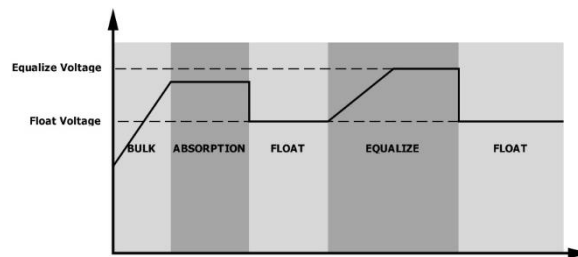

## ● Equalize charging time and timeout

In Equalize stage, the controller will supply power to charge battery as much as possible until battery voltage raises to battery equalization voltage. Then, constant-voltage regulation is applied to maintain battery voltage at the battery equalization voltage. The battery will remain in the Equalize stage until setting battery equalized time is arrived.

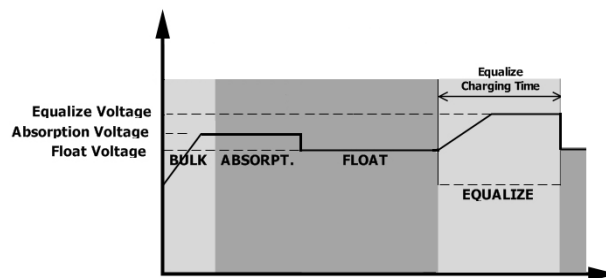

However, in Equalize stage, when battery equalized time is expired and battery voltage doesn't rise to battery equalization voltage point, the charge controller will extend the battery equalized time until battery voltage achieves battery equalization voltage. If battery voltage is still lower than battery equalization voltage when battery equalized timeout setting is over, the charge controller will stop equalization and return to float stage.

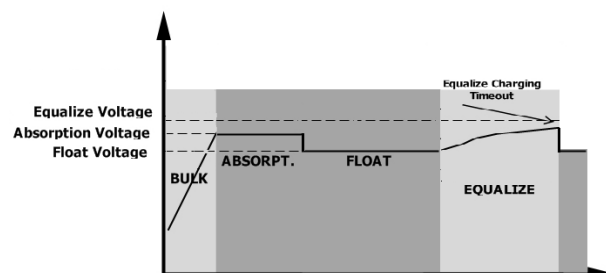

# CLEARANCE AND MAINTENANCE FOR ANTI-DUST KIT

## Overview

Every inverter is already installed with anti-dusk kit from factory. Inverter will automatically detect this kit and activate internal thermal sensor to adjust internal temperature. This kit also keeps dusk from your inverter and increases product reliability in harsh environment.

## Clearance and Maintenance

**Step 1:** Remove the screws on the top of the inverter.

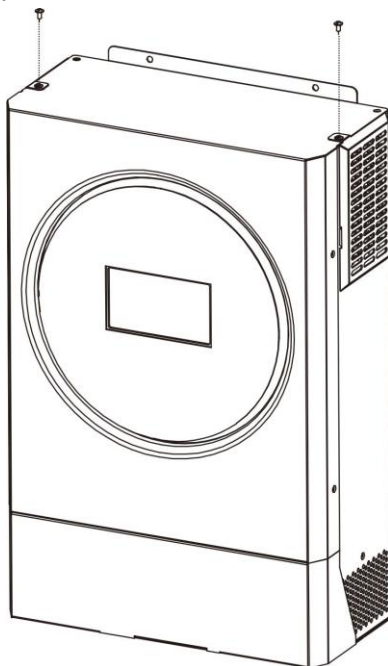

**Step 2:** Then, dustproof case can be removed and take out air filter foam as shown in below chart.

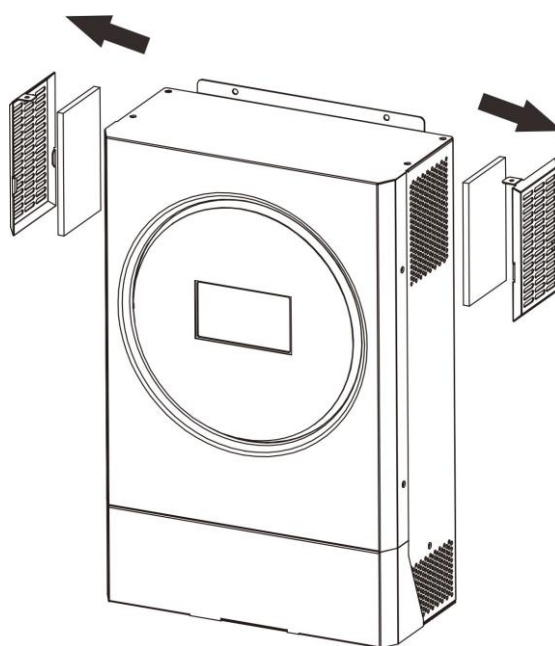

**Step 3:** Clean air filter foam and dustproof case. After clearance, re-assemble the dust-kit back to the inverter.

**NOTICE:** The anti-dust kit should be cleaned from dust every one month.



# SPECIFICATIONS

|                                       |   |
|---------------------------------------|---|
| <b>MODEL</b>                          | <b>Meta IX-6</b>  |
| <b>RATED OUTPUT POWER</b>             | 6000W   |
| <b>PV INPUT (DC)</b>                  |   |
| Max. PV Power                         | 7000W   |
| Max. PV Array Open Circuit Voltage    | 500 VDC   |
| PV Input Voltage Range                | 120 VDC~500 VDC   |
| MPPT Range @ Operating Voltage        | 120 VDC~430 VDC   |
| Max. PV Array Short Circuit Current   | 27A   |
| Number of MPP Tracker                 | 1   |
| <b>GRID-TIE OPERATION</b>             |   |
| <b>GRID OUTPUT (AC)</b>               |   |
| Nominal Output Voltage                | 220/230/240 VAC   |
| Feed-in Grid Voltage Range            | 195.5~253 VAC @India regulation<br>184 ~ 264.5 VAC @Germany regulation<br>184 ~ 264.5 VAC @South America regulation |
| Feed-in Grid Frequency Range          | 49~51Hz @India regulation<br>47.5~51.5Hz @Germany regulation<br>57~62Hz @South America                              |
| Nominal Output Current                | 26A   |
| Power Factor Range                    | >0.99   |
| Maximum Conversion Efficiency (DC/AC) | 96%   |
| <b>OFF-GRID, HYBRID OPERATION</b>     |   |
| <b>GRID INPUT</b>                     |   |
| Acceptable Input Voltage Range        | 90 - 280 VAC or 170 - 280 VAC   |
| Frequency Range                       | 50 Hz/60 Hz (Auto sensing)  |
| Transfer Time                         | < 10ms (For UPS)<br>< 20ms (For Home Appliances)<br>< 50ms (For parallel operation)                                 |
| Rating of AC Transfer Relay           | 40A   |
| <b>BATTERY MODE OUTPUT (AC)</b>       |   |
| Nominal Output Voltage                | 220/230/240 VAC   |
| Output Waveform                       | Pure Sine Wave  |
| Efficiency (DC to AC)                 | 93%   |
| <b>BATTERY &amp; CHARGER</b>          |   |
| Nominal DC Voltage                    | 48 VDC  |
| Maximum Charging Current (from Grid)  | 120A  |
| Maximum Charging Current (from PV)    | 120A  |
| Maximum Charging Current              | 120A  |
| <b>GENERAL</b>                        |   |
| Dimension, D X W X H (mm)             | 140 x 295 x 468   |
| Net Weight (kgs)                      | 12  |
| <b>INTERFACE</b>                      |   |
| Parallel-able                         | Yes   |
| External Safety Box (Optional)        | Yes   |
| Communication                         | RS232/Dry-Contact/WiFi  |
| <b>ENVIRONMENT</b>                    |   |
| Humidity                              | 0 ~ 90% RH (No condensing)  |
| Operating Temperature                 | -10°C to 50°C   |

# TROUBLE SHOOTING

| Problem   | LCD/LED/Buzzer  | Explanation / Possible cause  | What to do   |
|---|---|---|--|
| Unit shuts down automatically during startup process.                         | LCD/LEDs and buzzer will be active for 3 seconds and then complete off. | The battery voltage is too low (<1.91V/Cell)  | 1. Re-charge battery.<br>2. Replace battery.   |
| No response after power on.   | No indication.  | 1. The battery voltage is far too low. (<1.4V/Cell)<br>2. Battery polarity is connected reversed. | 1. Check if batteries and the wiring are connected well.<br>2. Re-charge battery.<br>3. Replace battery.   |
| Mains exist but the unit works in battery mode.                               | Input voltage is displayed as 0 on the LCD and green LED is flashing.   | Input protector is tripped  | Check if AC breaker is tripped and AC wiring is connected well.  |
|   | Green LED is flashing.  | Insufficient quality of AC power. (Shore or Generator)  | 1. Check if AC wires are too thin and/or too long.<br>2. Check if generator (if applied) is working well or if input voltage range setting is correct. (UPS→Appliance) |
|   | Green LED is flashing.  | Set "Solar First" as the priority of output source.   | Change output source priority to Utility first.  |
| When the unit is turned on, internal relay is switched on and off repeatedly. | LCD display and LEDs are flashing                                       | Battery is disconnected.  | Check if battery wires are connected well.   |
| Buzzer beeps continuously and red LED is on.                                  | Fault code 07   | Overload error. The inverter is overload 110% and time is up.                                     | Reduce the connected load by switching off some equipment.   |
|   | Fault code 05   | Output short circuited.   | Check if wiring is connected well and remove abnormal load.  |
|   | Fault code 02   | Internal temperature of inverter component is over 100°C.   | Check whether the air flow of the unit is blocked or whether the ambient temperature is too high.  |
|   | Fault code 03   | Battery is over-charged.  | Return to repair center.   |
|   |   | The battery voltage is too high.  | Check if spec and quantity of batteries are meet requirements.   |
|   | Fault code 01   | Fan fault   | Replace the fan.   |
|   | Fault code 06/58  | Output abnormal (Inverter voltage below than 190Vac or is higher than 260Vac)                     | 1. Reduce the connected load.<br>2. Return to repair center  |
|   | Fault code 08/09/53/57  | Internal components failed.   | Return to repair center.   |
|   | Fault code 10   | Surge   | Restart the unit, if the error happens again, please return to repair center.  |
|   | Fault code 12   | DC/DC over current or surge.  |  |
|   | Fault code 51   | Over current or surge.  |  |
|   | Fault code 52   | Bus voltage is too low.   |  |
|   | Fault code 55   | Output voltage is unbalanced.   |  |
| Fault code 56   | Battery is not connected well or fuse is burnt.                         | If the battery is connected well, please return to repair center.                                 |  |
| Fault code 11   | Solar input voltage is more than 500V.                                  | Solar input voltage is more than 500V.  |  |

# Appendix I: Parallel function

## 1. Introduction

This inverter can be used in parallel with two different operation modes.

1. Parallel operation in single phase is with up to 9 units. The supported maximum output power is 54KW/54KVA.
2. Maximum 9 units work together to support three-phase equipment. Maximum seven units support one phase.

**NOTE:** If this unit is bundled with share current cable and parallel cable, this inverter is default supported parallel operation. You may skip section 3. If not, please purchase parallel kit and install this unit by following instruction from professional technical personnel in local dealer.

**WARNING:** Please make sure all output N wires of each inverter should be connected always. Otherwise, it will cause fault in error #72.

## 2. Package Contents

In parallel kit, you will find the following items in the package:

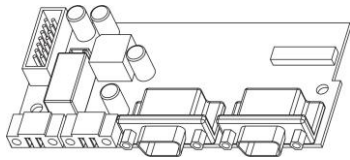

Parallel board

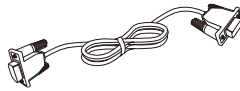

Parallel communication cable



Current sharing cable

## 3. Parallel board installation

**Step 1:** Remove wire cover by unscrewing all screws.

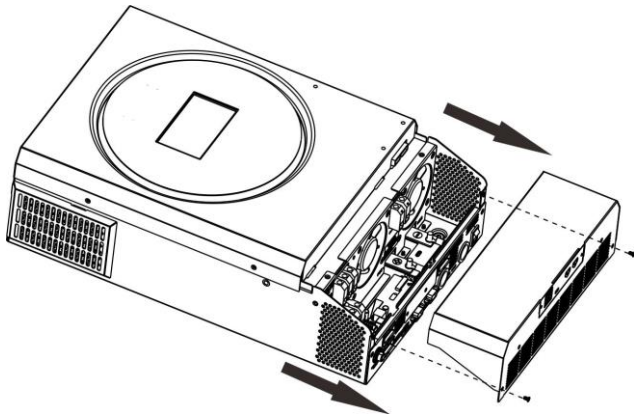

**Step 2:** Remove two screws as below chart and remove 2-pin and 14-pin cables. Take out the board under the communication board.

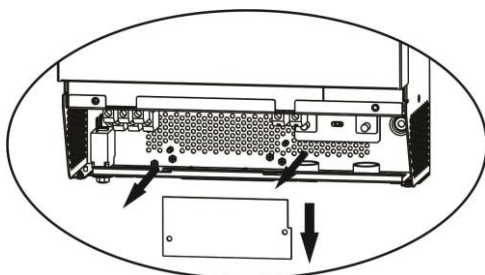

**Step 3:** Remove two screws as below chart to take out cover of parallel communication.

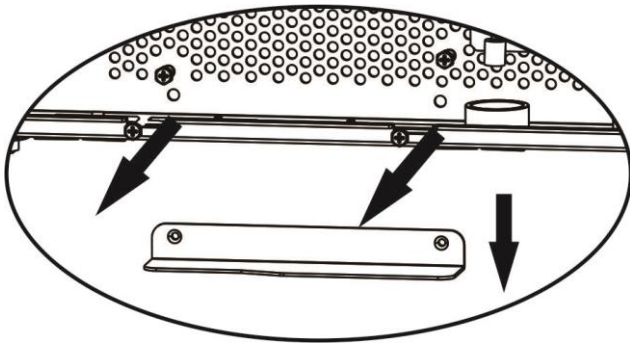

**Step 4:** Install new parallel board with 2 screws tightly.

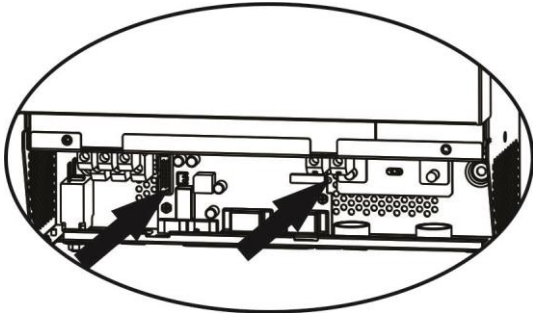

**Step 6:** Connect 2-pin to original position.

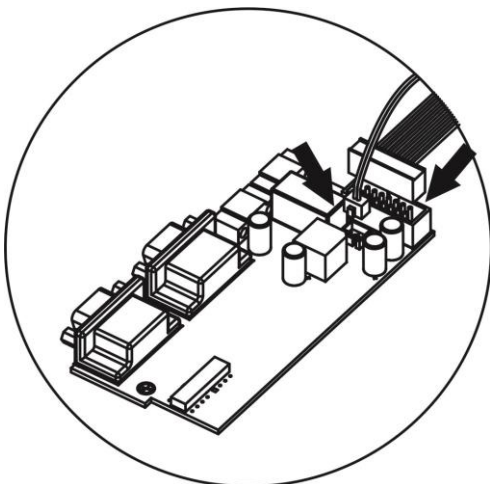

**Step 7:** Put communication board back to the unit.

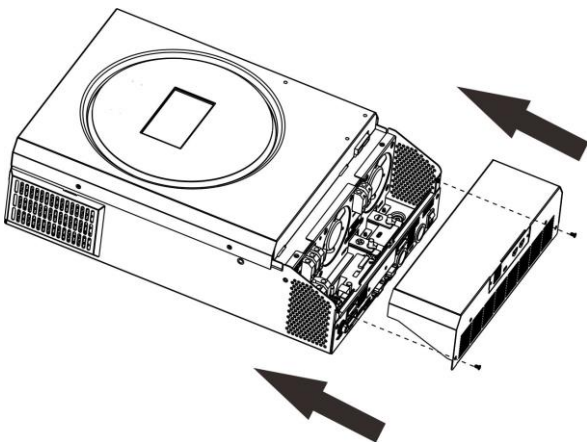

**Step 8:** Put wire cover back to the unit. Now the inverter is providing parallel operation function.

## 4. Mounting the Unit

When installing multiple units, please follow below chart.

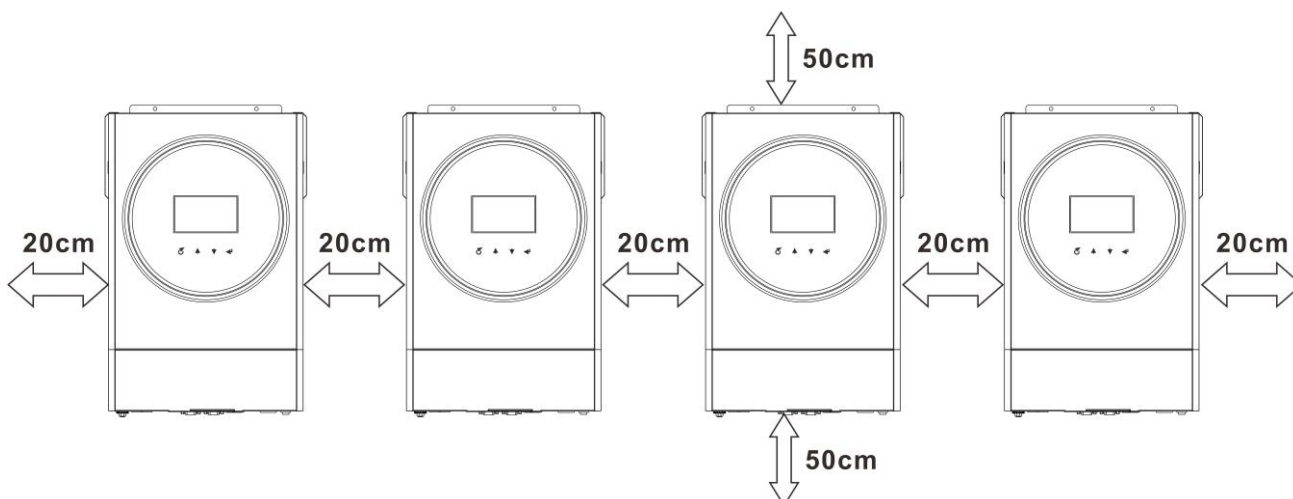

**NOTE:** For proper air circulation to dissipate heat, allow a clearance of approx. 20 cm to the side and approx. 50 cm above and below the unit. Be sure to install each unit in the same level.

## 5. Wiring Connection

**NOTICE:** It's requested to connect to battery for parallel operation.

The cable size of each inverter is shown as below:

**Recommended battery cable and terminal size for each inverter:**

| Model     | Wire Size        | Ring Terminal         |            | Torque value |        |
|-----------|------------------|-----------------------|------------|--------------|--------|
|           |                  | Cable mm <sup>2</sup> | Dimensions |              |        |
|           |                  |                       | D (mm)     | L (mm)       |        |
| Meta IX-6 | 1*2AWG or 2*6AWG | 28                    | 6.4        | 42.7         | 2~3 Nm |

**Ring terminal:**

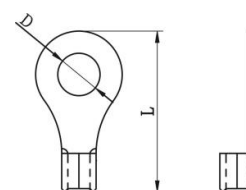

**WARNING:** Be sure the length of all battery cables is the same. Otherwise, there will be voltage difference between inverter and battery to cause parallel inverters not working.

**Recommended AC input and output cable size for each inverter:**

| Model     | AWG no. | Torque    |
|-----------|---------|-----------|
| Meta IX-6 | 10 AWG  | 1.2~1.6Nm |

You need to connect the cables of each inverter together. Take the battery cables for example: You need to use a connector or bus-bar as a joint to connect the battery cables together, and then connect to the battery terminal. The cable size used from joint to battery should be X times cable size in the tables above. "X" indicates the number of inverters connected in parallel.

Regarding AC input and output, please also follow the same principle.

**WARNING!!** Make sure all output N wires of each inverter must be connected all the time. Otherwise, it will cause inverter fault in error code #72.

**CAUTION!!** Please install the breaker at the battery and AC input side. This will ensure the inverter can be securely disconnected during maintenance and fully protected from over current of battery or AC input. The recommended mounted location of the breakers is shown in the figures in 5-1 and 5-2.

**Recommended breaker specification of battery for each inverter:**

|           |            |
|-----------|------------|
| Model     | 1 unit*    |
| Meta IX-6 | 140A/70VDC |

\*If you want to use only one breaker at the battery side for the whole system, the rating of the breaker should be X times current of 1 unit. "X" indicates the number of inverters connected in parallel.

**Recommended breaker specification of AC input with single phase:**

|           |                |                 |                 |                 |                 |                 |                 |                 |
|-----------|----------------|-----------------|-----------------|-----------------|-----------------|-----------------|-----------------|-----------------|
| Model     | 2 units        | 3 units         | 4 units         | 5 units         | 6 units         | 7 units         | 8 units         | 9 units         |
| Meta IX-6 | 80A/<br>230VAC | 120A/<br>230VAC | 160A/<br>230VAC | 200A/<br>230VAC | 240A/<br>230VAC | 280A/<br>230VAC | 320A/<br>230VAC | 360A/<br>230VAC |

**Note1:** Also, you can use 50A for only 1 unit and install one breaker at its AC input in each inverter.

**Note2:** Regarding three-phase system, you can use 4-pole breaker directly and the rating of the breaker should be compatible with the phase current limitation from the phase with maximum units

**Recommended battery capacity**

|                           |       |       |       |        |        |        |        |        |
|---------------------------|-------|-------|-------|--------|--------|--------|--------|--------|
| Inverter parallel numbers | 2     | 3     | 4     | 5      | 6      | 7      | 8      | 9      |
| Battery Capacity          | 400AH | 600AH | 800AH | 1000AH | 1200AH | 1400AH | 1600AH | 1800AH |

**WARNING!** Be sure that all inverters will share the same battery bank. Otherwise, the inverters will transfer to fault mode.

**5-1. Parallel Operation in Single phase**

Two inverters in parallel:

**Power Connection**

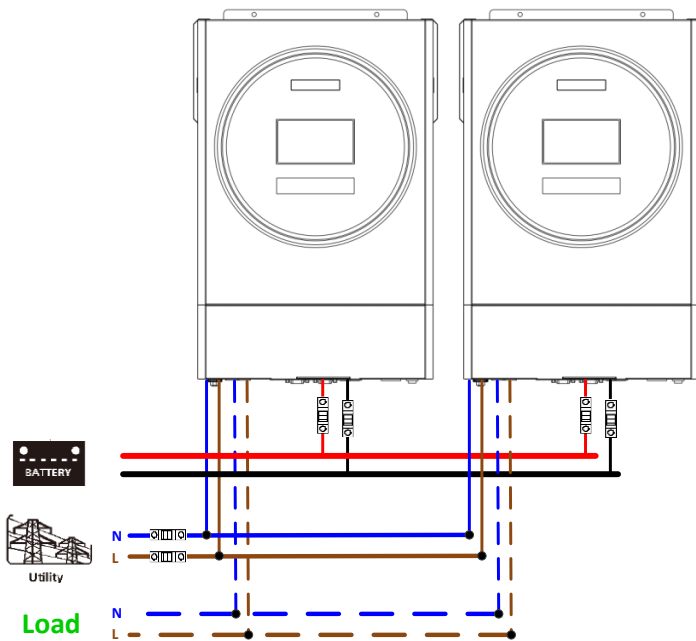

### Communication Connection

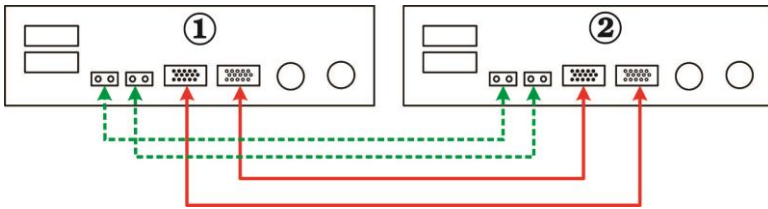

Three inverters in parallel:

### Power Connection

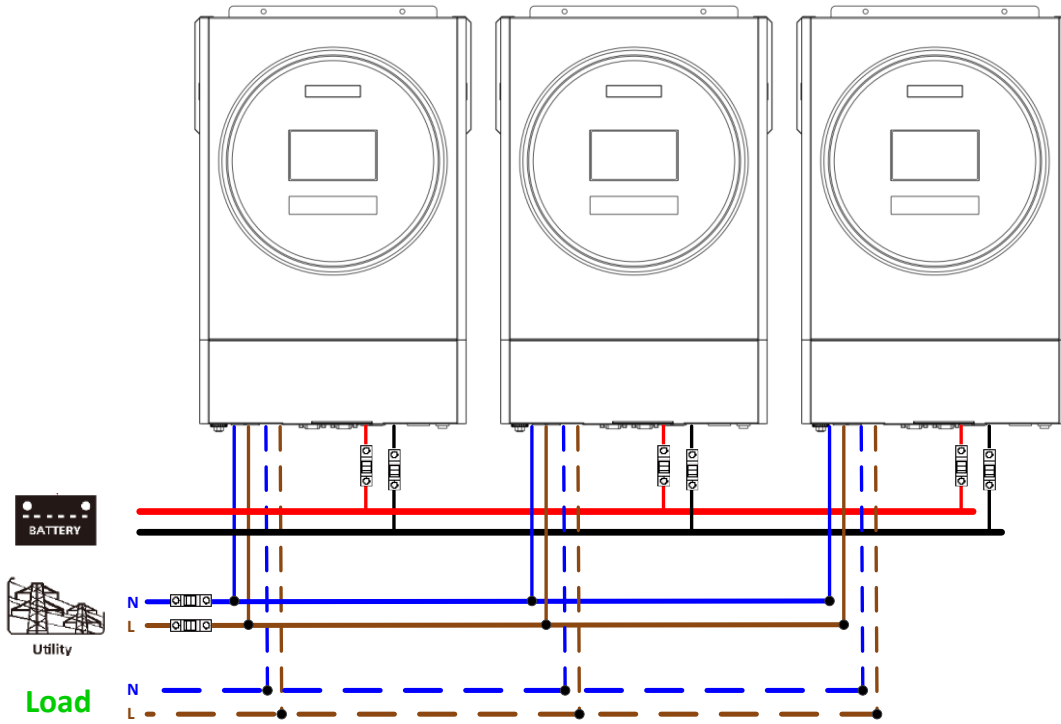

### Communication Connection

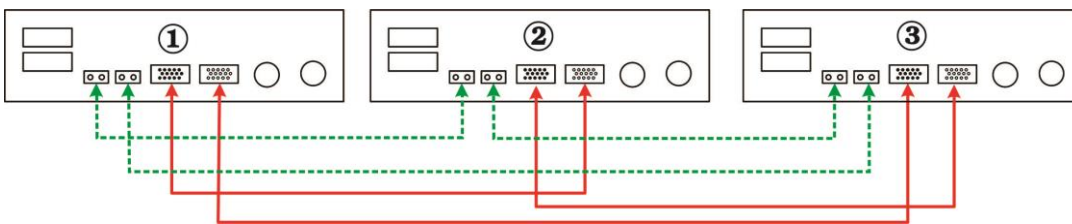

Four inverters in parallel:

### Power Connection

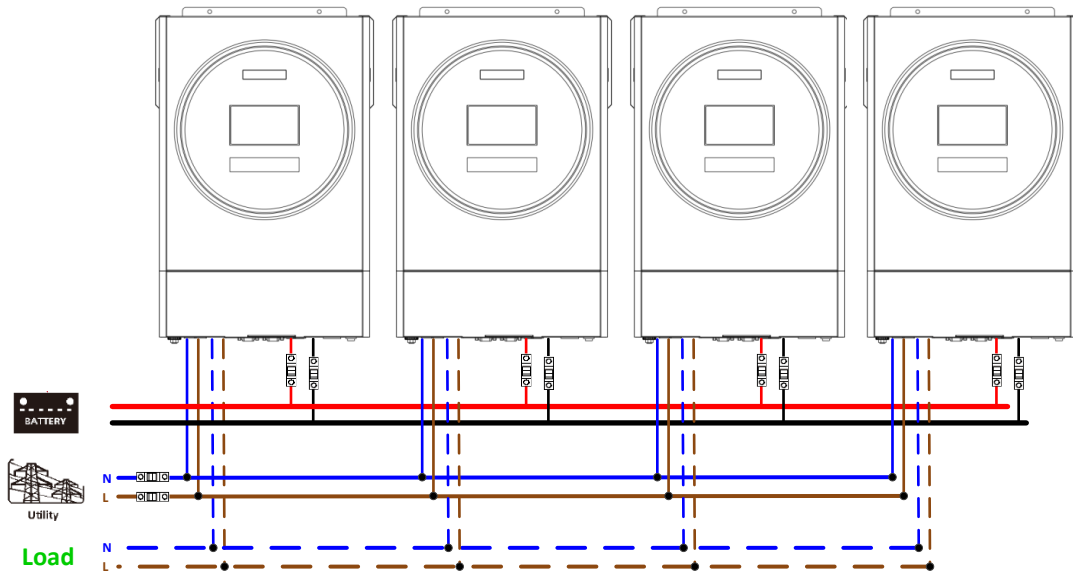

### Communication Connection

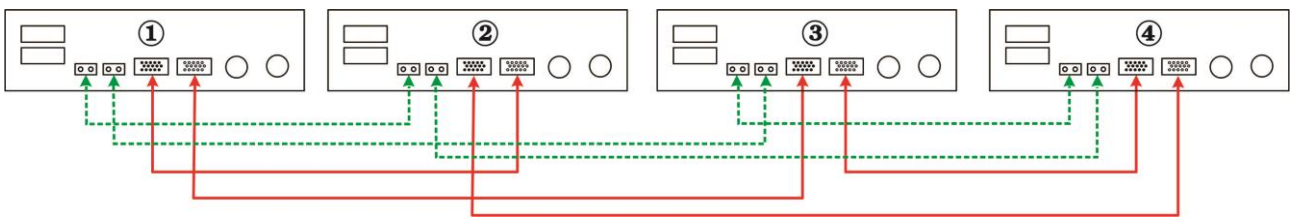

Five inverters in parallel:

### Power Connection

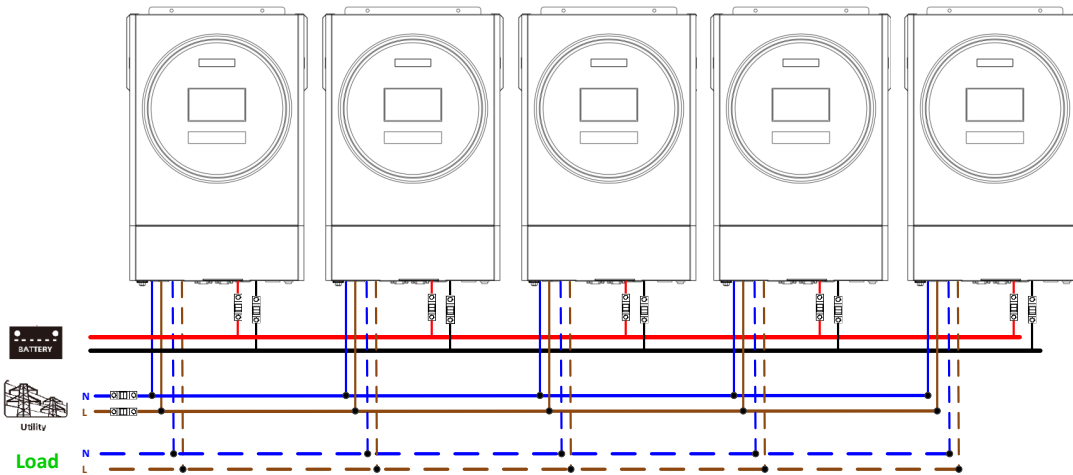

### Communication Connection

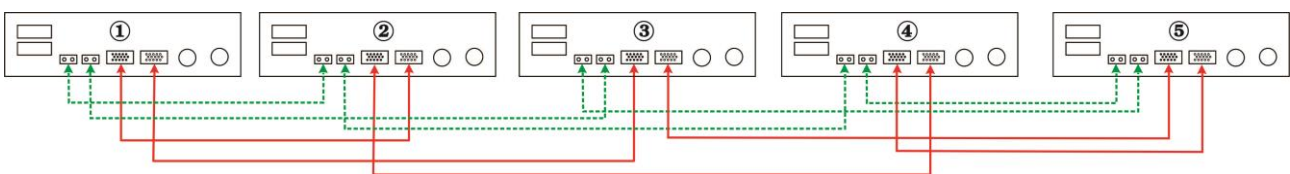



Six inverters in parallel:

### Power Connection

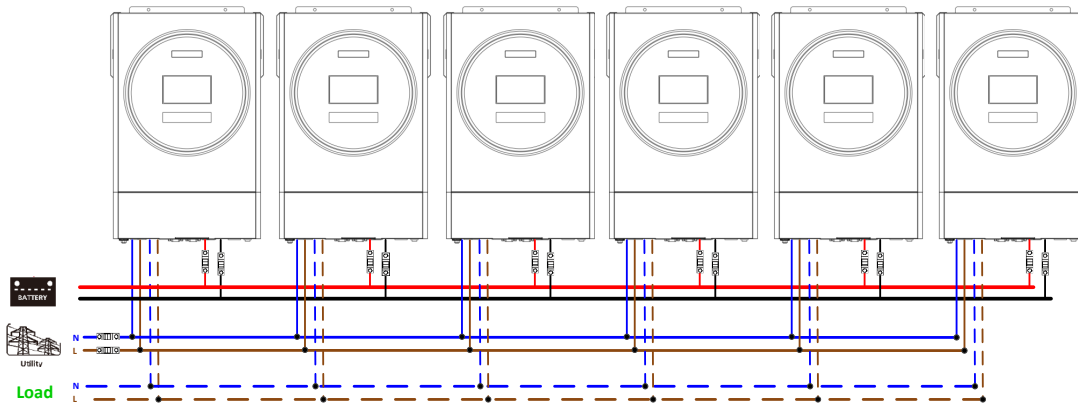

### Communication Connection

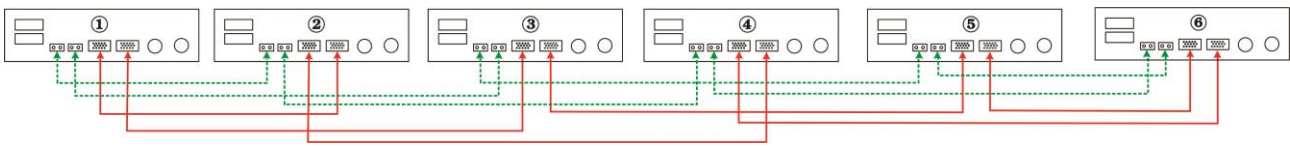

Seven inverters in parallel:

### Power Connection

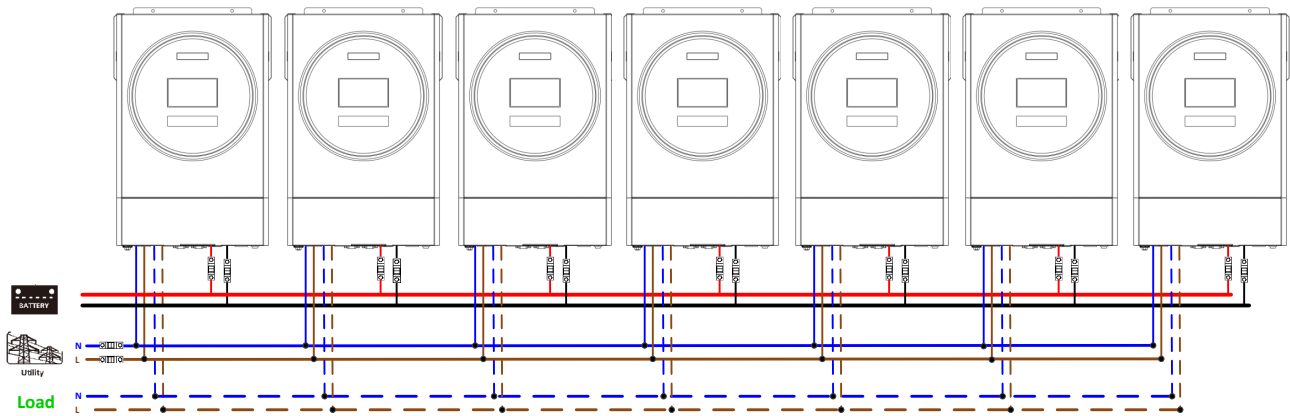

### Communication Connection

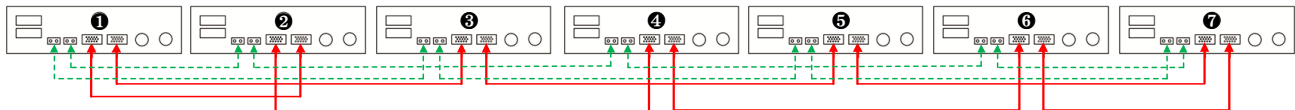

Eight inverters in parallel:

### Power Connection

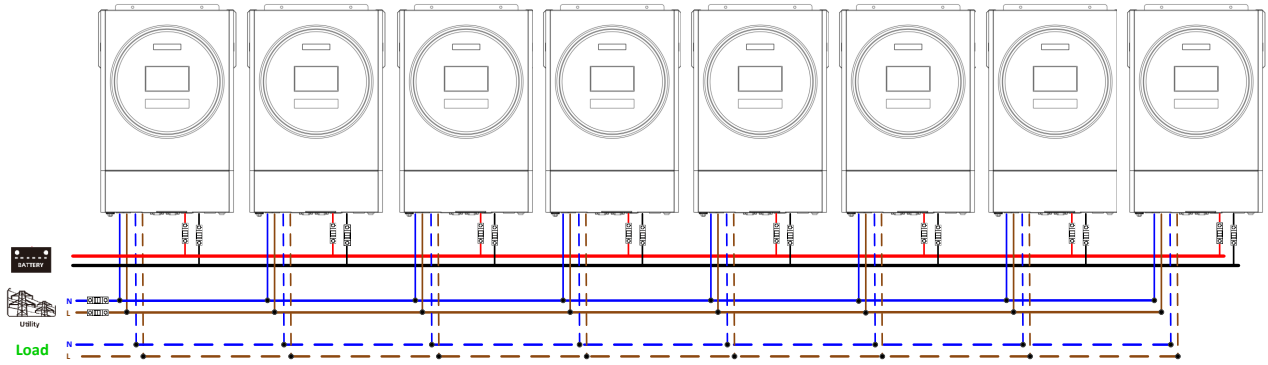

### Communication Connection

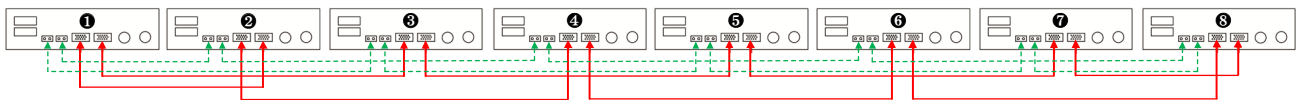

Nine inverters in parallel:

### Power Connection

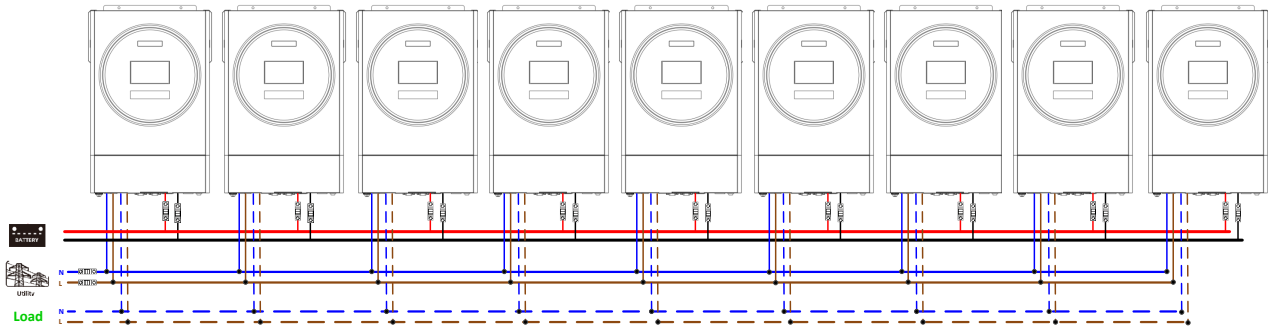

### Communication Connection

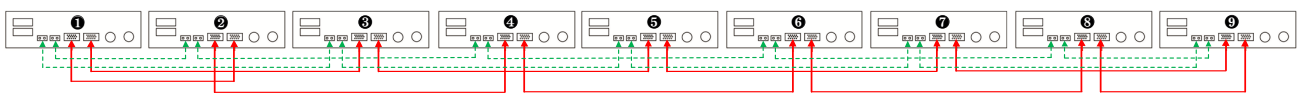

## 5-2. Support 3-phase equipment

Three inverters in each phase:

### Power Connection

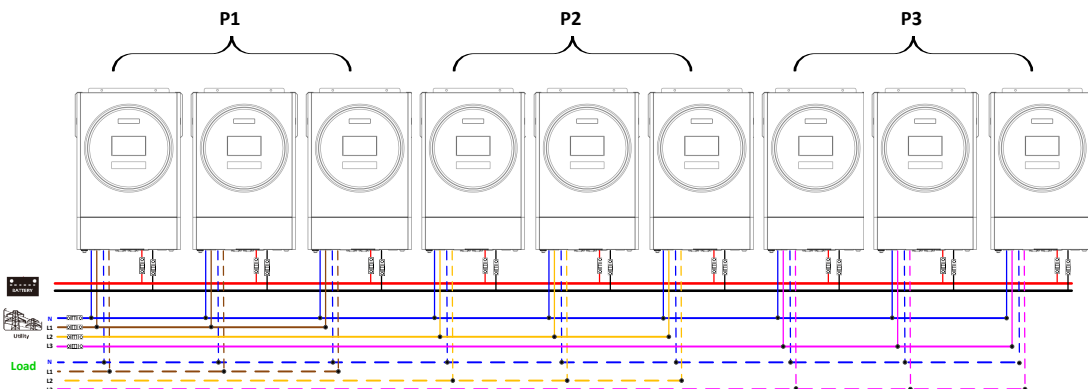

**Communication Connection**

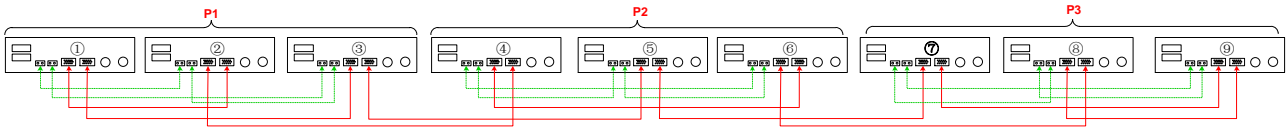

Three inverters in one phase, three inverters in second phase and two inverter for the third phase:

**Power Connection**

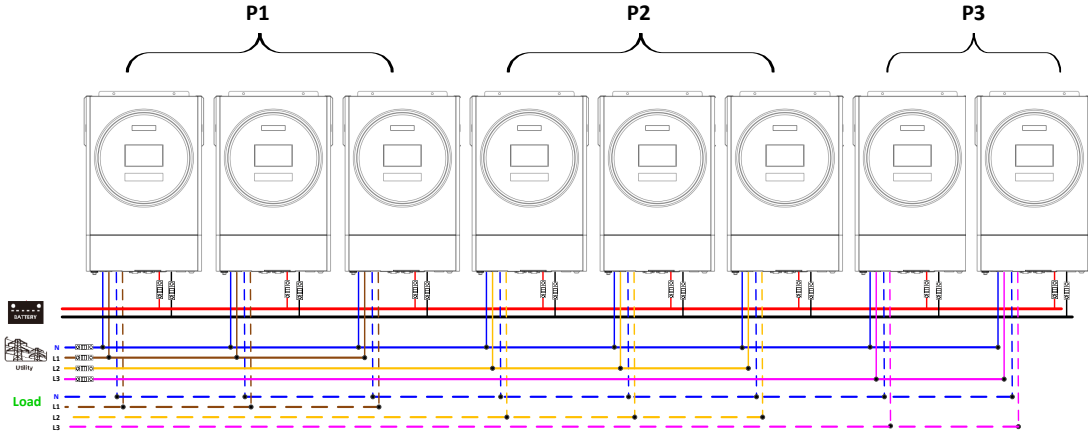

**Communication Connection**

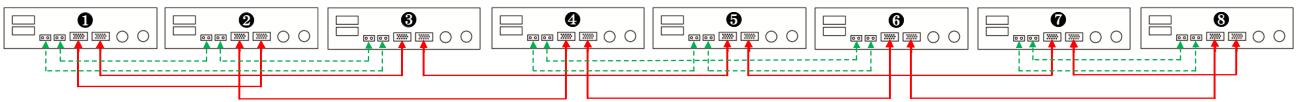

Seven inverters in one phase and one inverter for the other two phases:

**Power Connection**

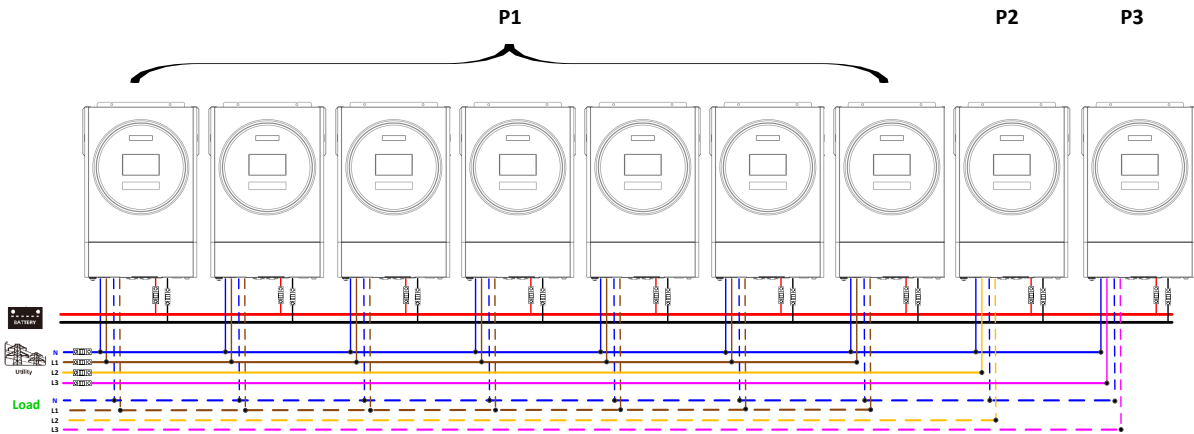

**Note:** It's up to customer's demand to pick 7 inverters on any phase.

P1: L1-phase, P2: L2-phase, P3: L3-phase.

**Communication Connection**

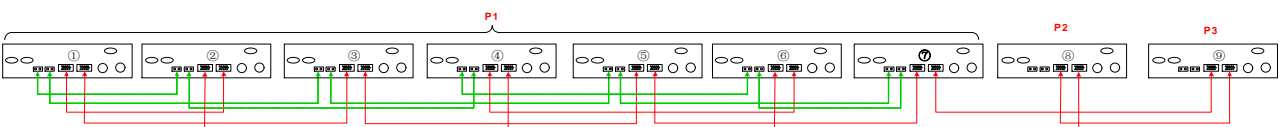

**Note:** If there is only one unit in one phase, this unit doesn't need to connect the current sharing cable.

Or you connect it like as below:

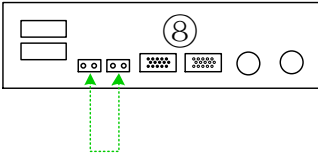

Three inverters in one phase, two inverters in second phase and two inverters for the third phase:

**Power Connection**

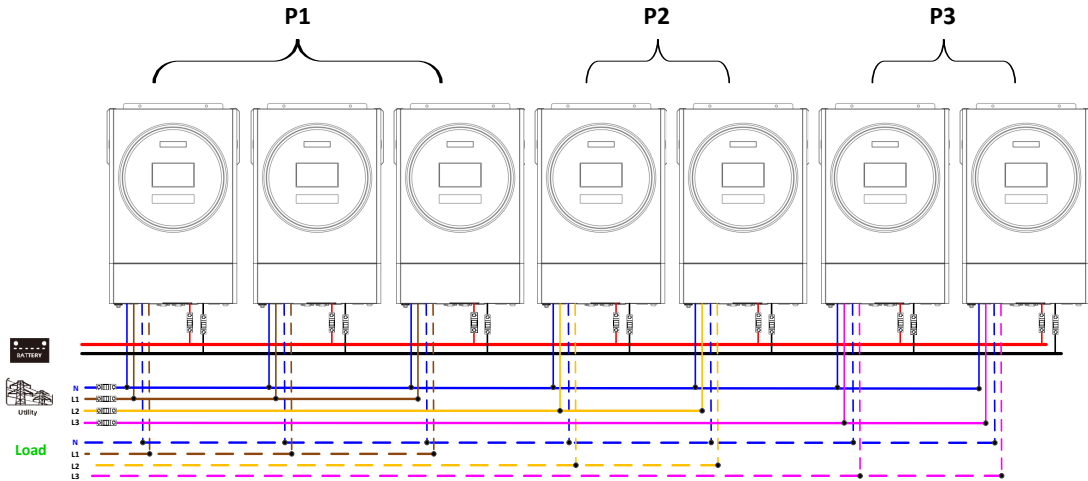

**Communication Connection**

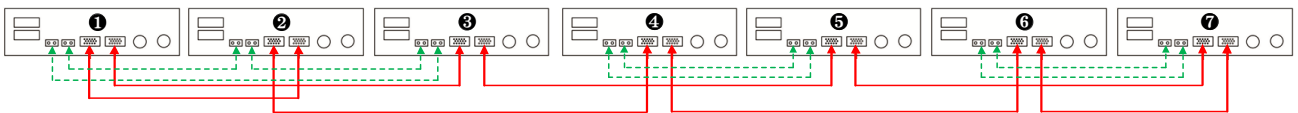

Two inverters in each phase:

**Power Connection**

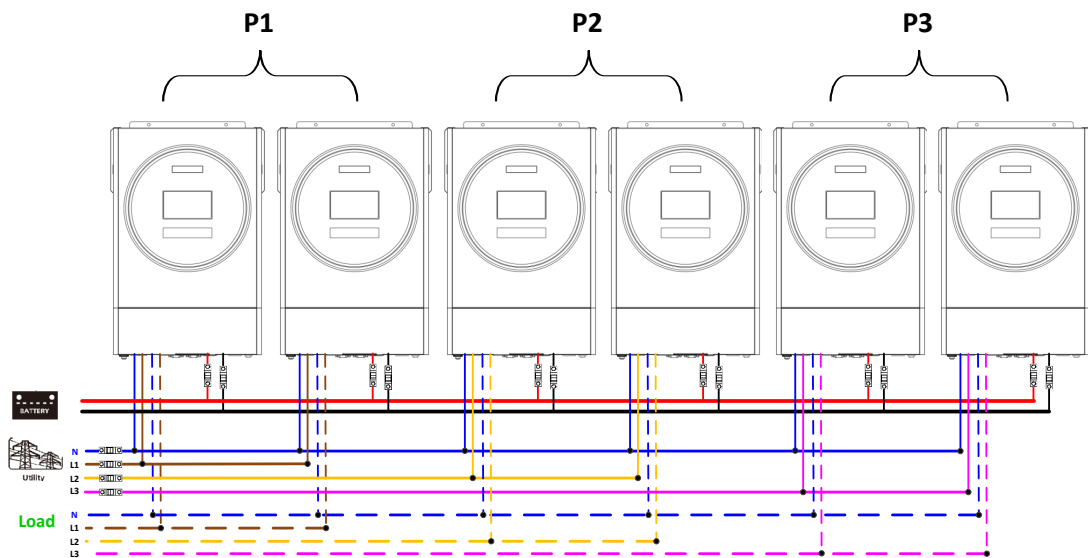

**Communication Connection**

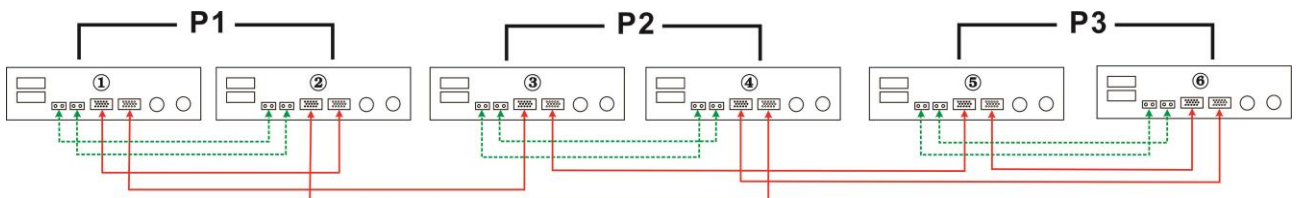

Four inverters in one phase and one inverter for the other two phases:

**Power Connection**

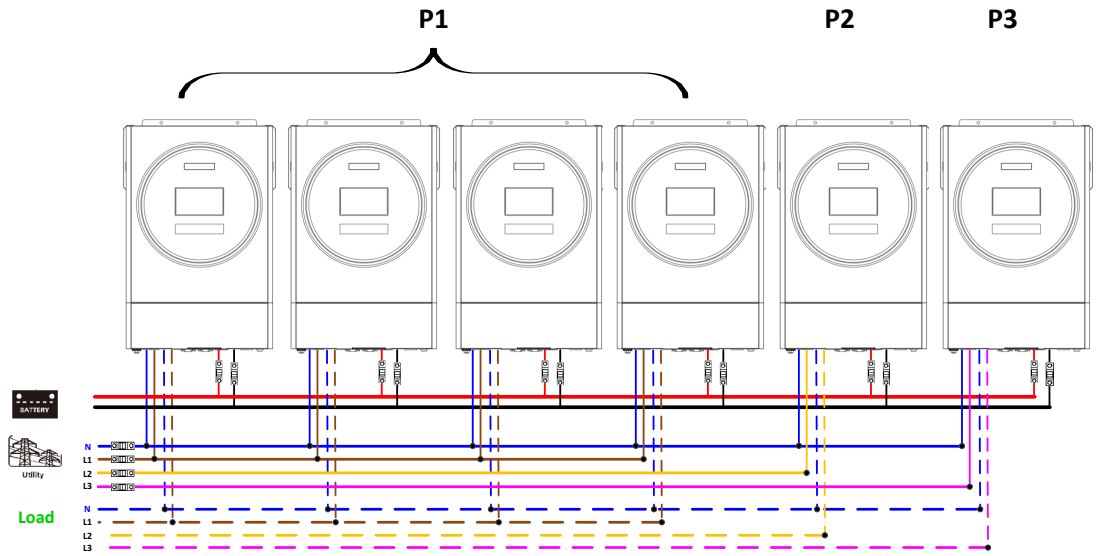

**Communication Connection**

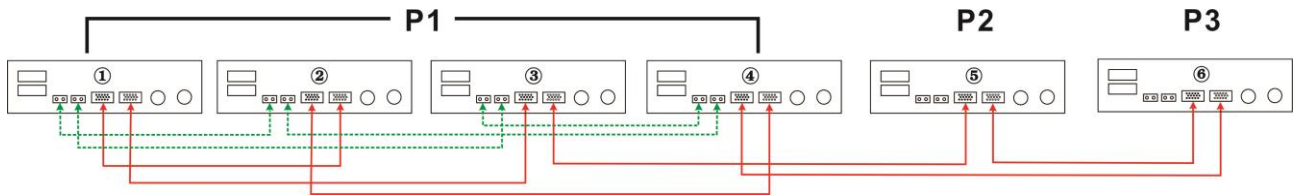

Three inverters in one phase, two inverters in second phase and one inverter for the third phase:

**Power Connection**

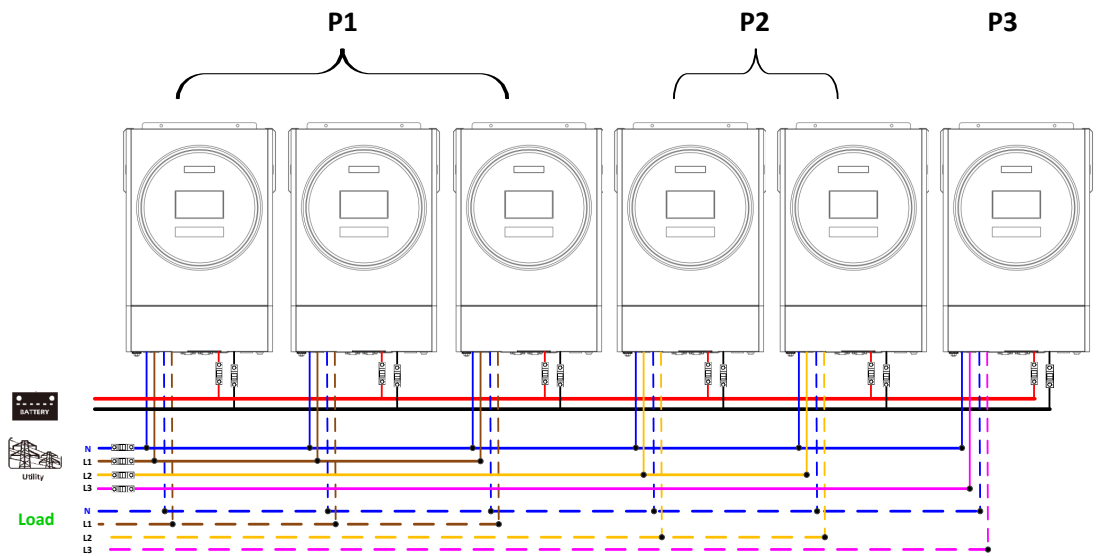

**Communication Connection**

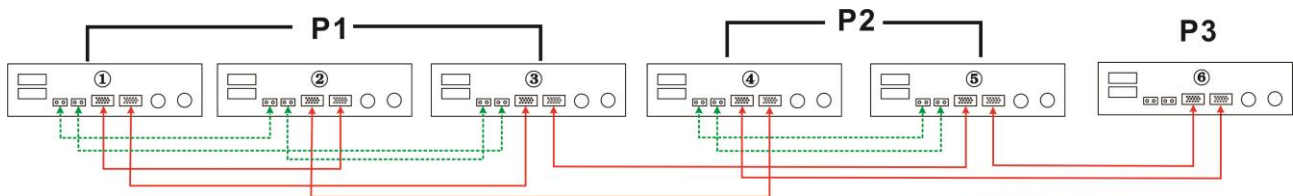

Three inverters in one phase and only one inverter for the remaining two phases:

**Power Connection**

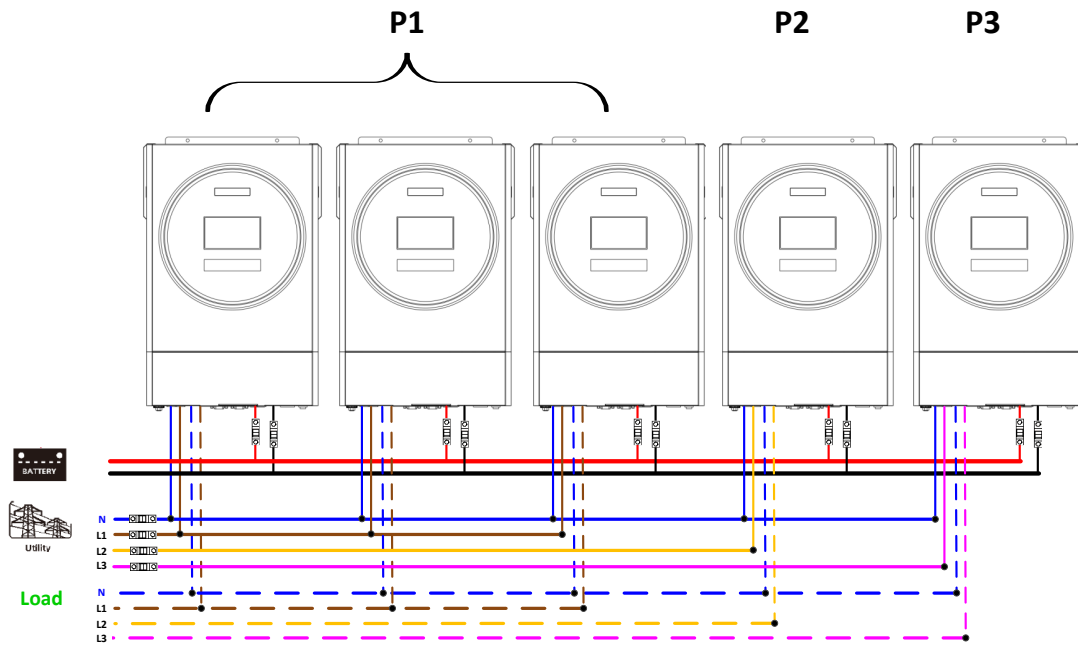

**Communication Connection**

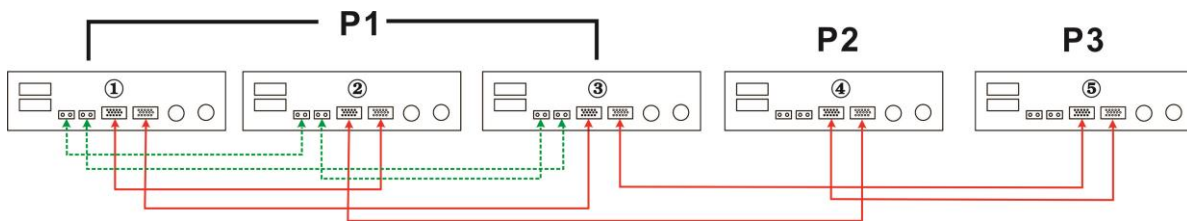

Two inverters in two phases and only one inverter for the remaining phase:

**Power Connection**

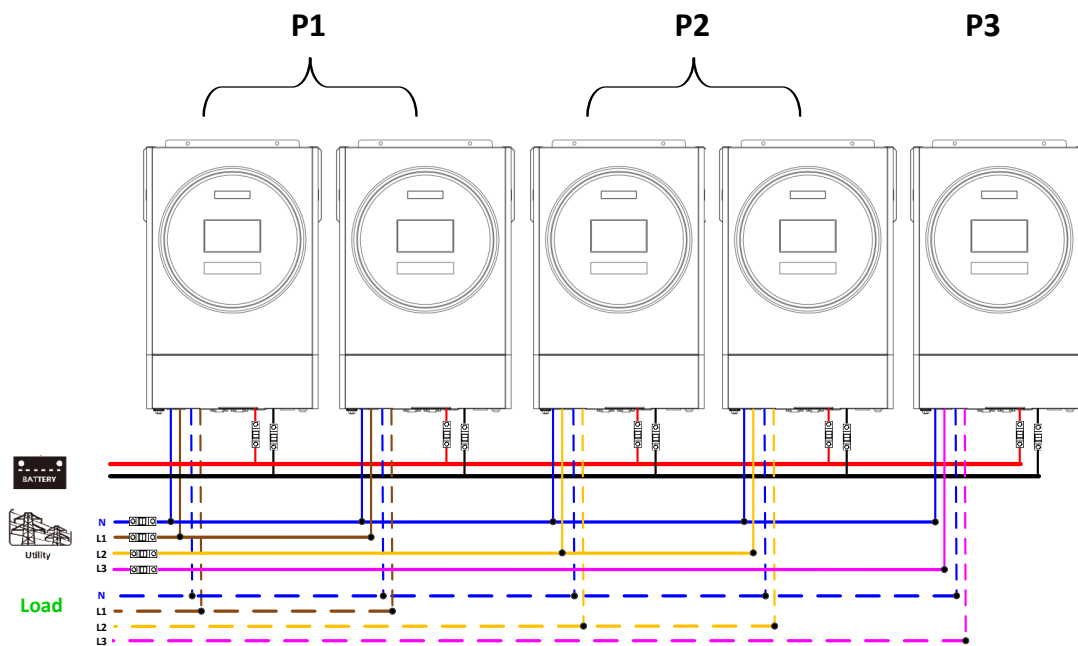

**Communication Connection**

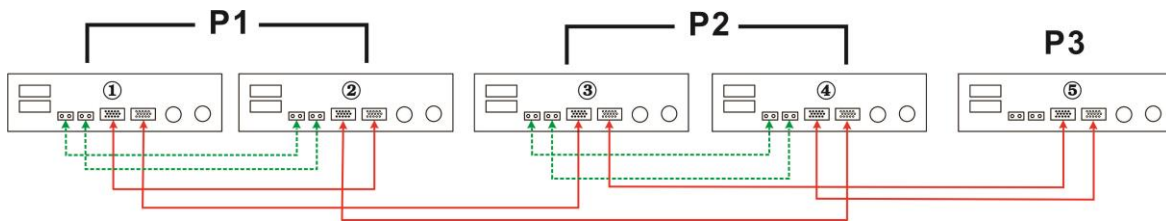

Two inverters in one phase and only one inverter for the remaining phases:

**Power Connection**

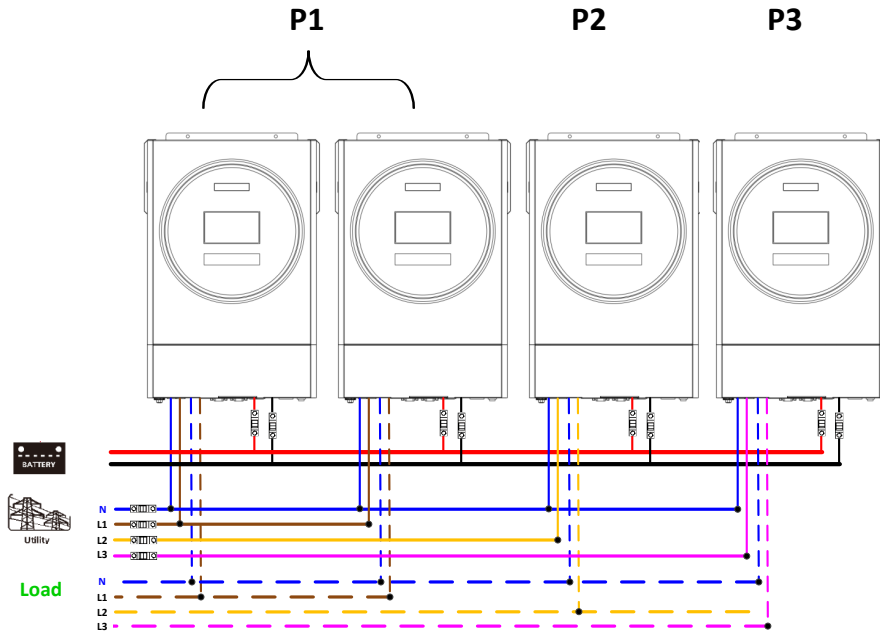

**Communication Connection**

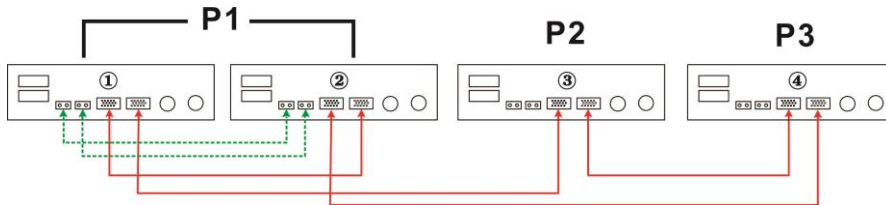

One inverter in each phase:

**Power Connection**

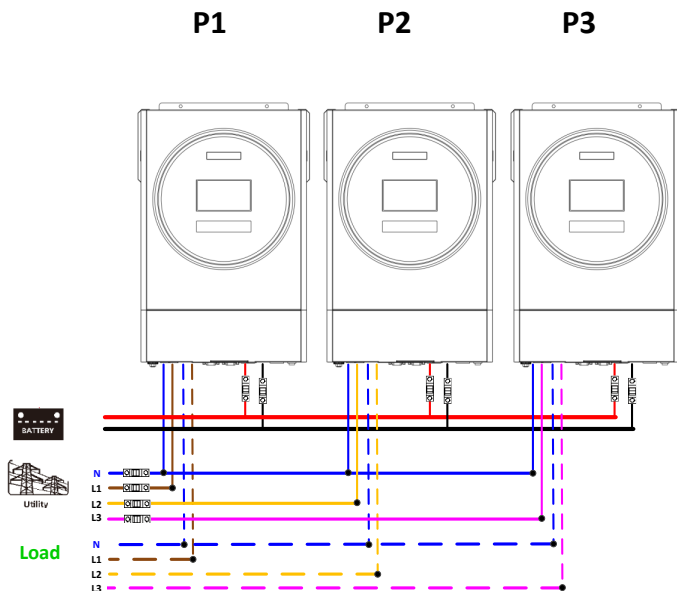

## Communication Connection

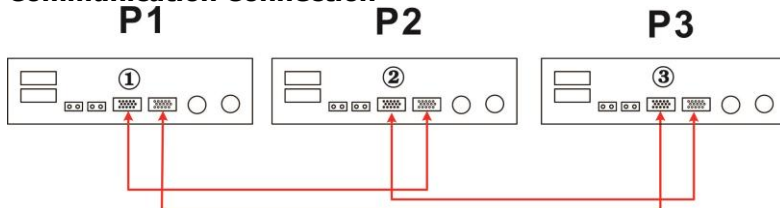

**WARNING:** Do not connect the current sharing cable between the inverters which are in different phases. Otherwise, it may damage the inverters.

## 6. PV Connection

Please refer to user manual of single unit for PV Connection.

**CAUTION:** Each inverter should connect to PV modules separately.

## 7. LCD Setting and Display

### Setting Program:

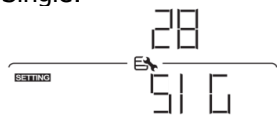
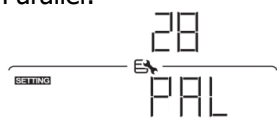
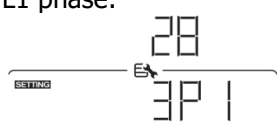
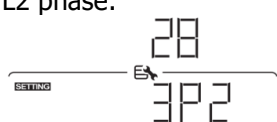
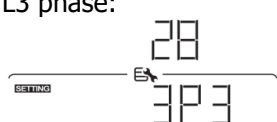
| Program | Description  | Selectable option  |  |
|---------|--|--|--|
| 28      | AC output mode<br>*This setting is only available when the inverter is in standby mode (Switch off). | Single:<br>     | When the units are used in parallel with single phase, please select "PAL" in program 28.  |
|         |  | Parallel:<br>  | It is required to have at least 3 inverters or maximum 9 inverters to support three-phase equipment. It's required to have at least one inverter in each phase or it's up to four inverters in one phase. Please refers to 5-2 for detailed information. |
|         |  | L1 phase:<br> | Please select "3P1" in program 28 for the inverters connected to L1 phase, "3P2" in program 28 for the inverters connected to L2 phase and "3P3" in program 28 for the inverters connected to L3 phase.  |
|         |  | L2 phase:<br> | Be sure to connect share current cable to units which are on the same phase. Do NOT connect share current cable between units on different phases.   |
|         |  | L3 phase:<br> | Besides, power saving function will be automatically disabled.   |



**Fault code display:**

| <b>Fault Code</b> | <b>Fault Event</b>                                | <b>Icon on</b> |
|-------------------|---|----------------|
| 60                | Power feedback protection                         | F60            |
| 71                | Firmware version inconsistent                     | F71            |
| 72                | Current sharing fault                             | F72            |
| 80                | CAN fault   | F80            |
| 81                | Host loss   | F81            |
| 82                | Synchronization loss                              | F82            |
| 83                | Battery voltage detected different                | F83            |
| 84                | AC input voltage and frequency detected different | F84            |
| 85                | AC output current unbalance                       | F85            |
| 86                | AC output mode setting is different               | F86            |

**Code Reference:**

| <b>Code</b> | <b>Description</b>                     | <b>Icon on</b> |
|-------------|--|----------------|
| NE          | Un-identified unit for master or slave | NE             |
| HS          | Master unit                            | HS             |
| SL          | Slave unit                             | SL             |

## 8. Commissioning

### Parallel in single phase

Step 1: Check the following requirements before commissioning:

- Correct wire connection
- Ensure all breakers in Line wires of load side are open and each Neutral wires of each unit are connected together.

Step 2: Turn on each unit and set "PAL" in LCD setting program 28 of each unit. And then shut down all units.

**NOET:** It's necessary to turn off switch when setting LCD program. Otherwise, the setting can not be programmed.

Step 3: Turn on each unit.

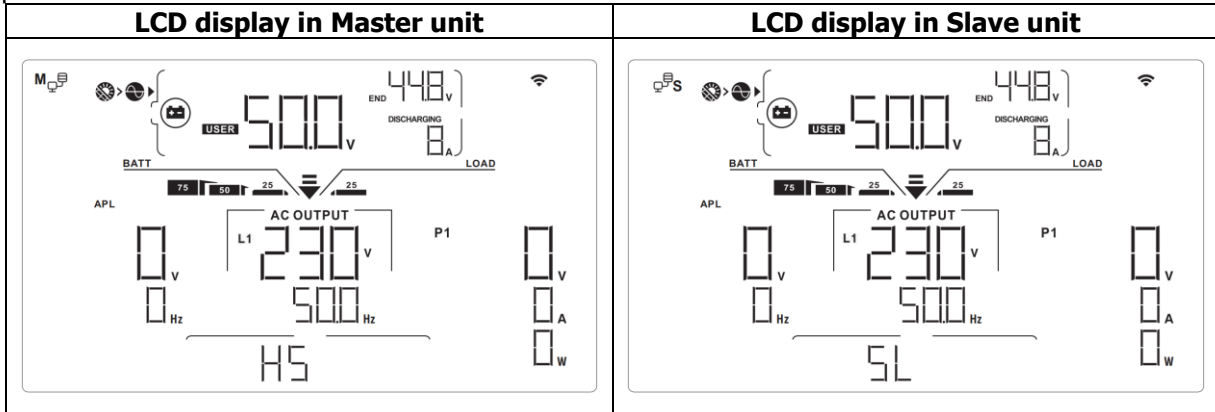

**NOTE:** Master and slave units are randomly defined. Step 4: Switch on all AC breakers of Line wires in AC input. It's better to have all inverters connect to utility at the same time. If not, it will display fault 82 in following-order inverters. However, these inverters will automatically restart. If detecting AC connection, they will work normally.

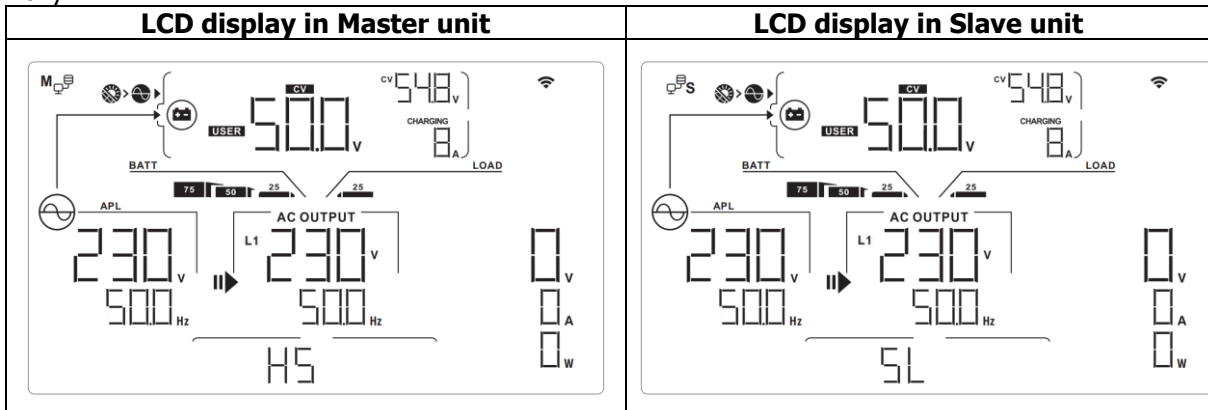

Step 5: If there is no more fault alarm, the parallel system is completely installed.

Step 6: Please switch on all breakers of Line wires in load side. This system will start to provide power to the load.

### Support three-phase equipment

Step 1: Check the following requirements before commissioning:

- Correct wire connection
- Ensure all breakers in Line wires of load side are open and each Neutral wires of each unit are connected together.

Step 2: Turn on all units and configure LCD program 28 as P1, P2 and P3 sequentially. And then shut down all units.

**NOET:** It's necessary to turn off switch when setting LCD program. Otherwise, the setting can not be programmed.

Step 3: Turn on all units sequentially.

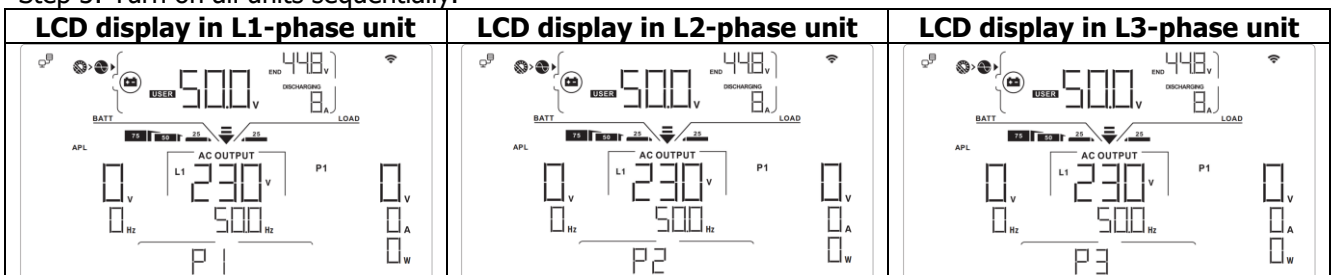

Step 4: Switch on all AC breakers of Line wires in AC input. If AC connection is detected and three phases are

matched with unit setting, they will work normally. Otherwise, the AC icon  will flash and they will not work in line mode.

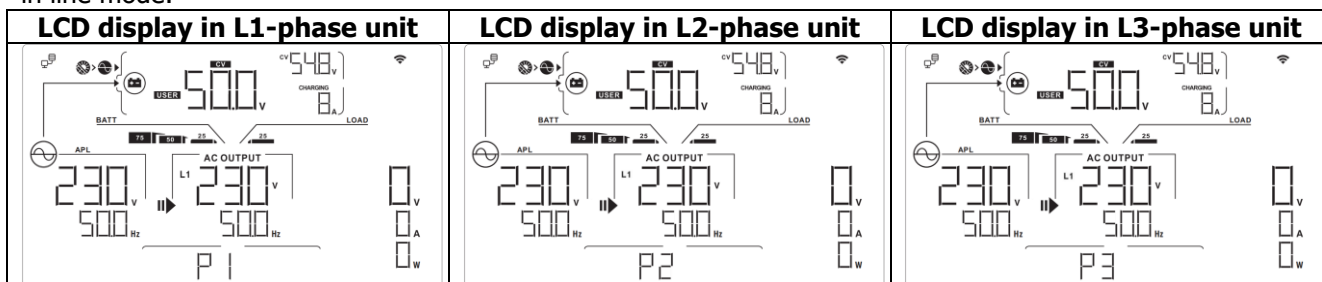

Step 5: If there is no more fault alarm, the system to support 3-phase equipment is completely installed.

Step 6: Please switch on all breakers of Line wires in load side. This system will start to provide power to the load.

Note 1: To avoid overload occurring, before turning on breakers in load side, it's better to have whole system in operation first.

Note 2: Transfer time for this operation exists. Power interruption may happen to critical devices, which cannot bear transfer time.

## 9. Trouble shooting

| Situation  |  | Solution   |
|------------|--|--|
| Fault Code | Fault Event Description                                |  |
| 60         | Current feedback into the inverter is detected.        | <ol style="list-style-type: none"> <li>Restart the inverter.</li> <li>Check if L/N cables are not connected reversely in all inverters.</li> <li>For parallel system in single phase, make sure the sharing are connected in all inverters.<br/>For supporting three-phase system, make sure the sharing cables are connected in the inverters in the same phase, and disconnected in the inverters in different phases.</li> <li>If the problem remains, please contact your installer.</li> </ol>                                      |
| 71         | The firmware version of each inverter is not the same. | <ol style="list-style-type: none"> <li>Update all inverter firmware to the same version.</li> <li>Check the version of each inverter via LCD setting and make sure the CPU versions are same. If not, please contact your instraller to provide the firmware to update.</li> <li>After updating, if the problem still remains, please contact your installer.</li> </ol>   |
| 72         | The output current of each inverter is different.      | <ol style="list-style-type: none"> <li>Check if sharing cables are connected well and restart the inverter.</li> <li>If the problem remains, please contact your installer.</li> </ol>   |
| 80         | CAN data loss  | <ol style="list-style-type: none"> <li>Check if communication cables are connected well and restart the inverter.</li> <li>If the problem remains, please contact your installer.</li> </ol>   |
| 81         | Host data loss   |  |
| 82         | Synchronization data loss                              |  |
| 83         | The battery voltage of each inverter is not the same.  | <ol style="list-style-type: none"> <li>Make sure all inverters share same groups of batteries together.</li> <li>Remove all loads and disconnect AC input and PV input. Then, check battery voltage of all inverters. If the values from all inverters are close, please check if all battery cables are the same length and same material type. Otherwise, please contact your installer to provide SOP to calibrate battery voltage of each inverter.</li> <li>If the problem still remains, please contact your installer.</li> </ol> |
| 84         | AC input voltage and frequency are detected different. | <ol style="list-style-type: none"> <li>Check the utility wiring connction and restart the inverter.</li> <li>Make sure utility starts up at same time. If there are breakers installed between utility and inverters, please be sure all breakers can be turned on AC input at same time.</li> <li>If the problem remains, please contact your installer.</li> </ol>   |
| 85         | AC output current unbalance                            | <ol style="list-style-type: none"> <li>Restart the inverter.</li> <li>Remove some excessive loads and re-check load information from LCD of inverters. If the values are different, please check if AC input and output cables are in the same length and material type.</li> <li>If the problem remains, please contact your installer.</li> </ol>  |
| 86         | AC output mode setting is different.                   | <ol style="list-style-type: none"> <li>Switch off the inverter and check LCD setting #28.</li> <li>For parallel system in single phase, make sure no 3P1, 3P2 or 3P3 is set on #28.</li> </ol>   |

For supporting three-phase system, make sure no "PAL" is set on #28.  
 3. If the problem remains, please contact your installer.

## Appendix II: BMS Communication Installation

### 1. Introduction

If connecting to lithium battery, it is recommended to purchase a custom-made RJ45 communication cable. Please check with your dealer or integrator for details.

This custom-made RJ45 communication cable delivers information and signal between lithium battery and the inverter. These information are listed below:

- Re-configure charging voltage, charging current and battery discharge cut-off voltage according to the lithium battery parameters.
- Have the inverter start or stop charging according to the status of lithium battery.

### 2. Pin Assignment for BMS Communication Port

|       | Definition |
|-------|------------|
| PIN 1 | RS232TX    |
| PIN 2 | RS232RX    |
| PIN 3 | RS485B     |
| PIN 4 | NC         |
| PIN 5 | RS485A     |
| PIN 6 | CANH       |
| PIN 7 | CANL       |
| PIN 8 | GND        |

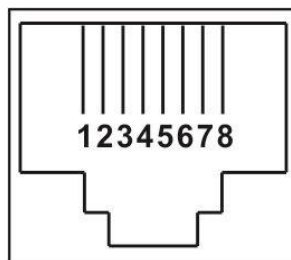

### 3. Lithium Battery Communication Configuration

#### LIO-4805/LIO-4810-150A

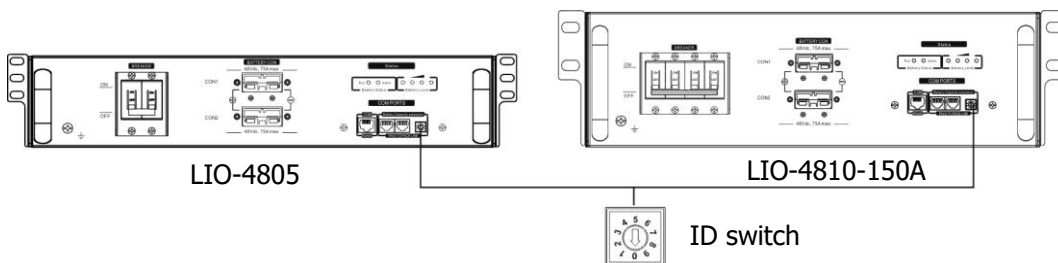

#### ESS LIO-I 4810

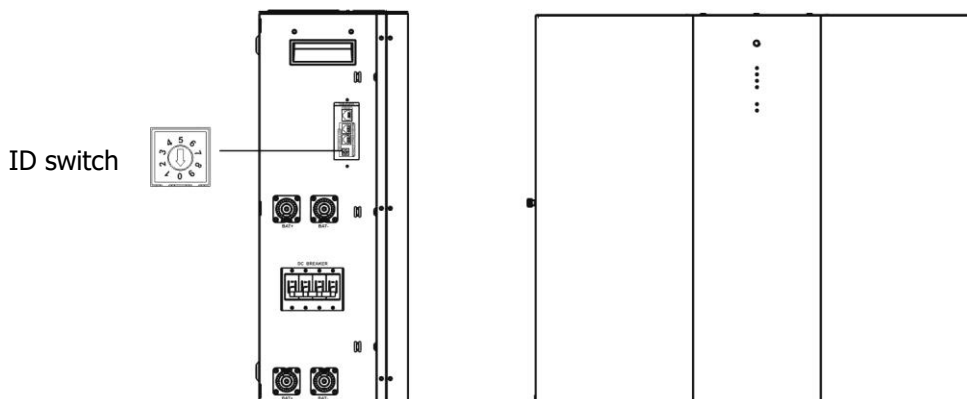

ID Switch indicates the unique ID code for each battery module. It's required to assign a unique ID to each battery module for normal operation. We can set up the ID code for each battery module by rotating the PIN number on the ID switch. From number 0 to 9, the number can be random; no particular order. Maximum 10 battery modules can be operated in parallel.

**PYLONTECH**

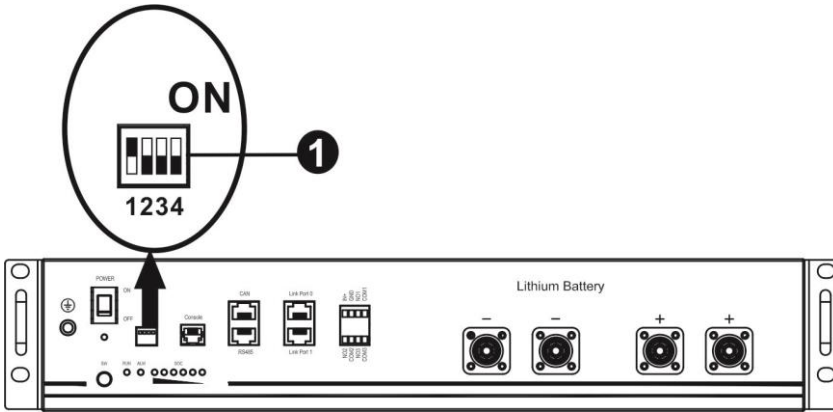

Dip Switch: There are 4 Dip Switches that sets different baud rate and battery group address. If switch position is turned to the "OFF" position, it means "0". If switch position is turned to the "ON" position, it means "1".

Dip 1 is "ON" to represent the baud rate 9600.

Dip 2, 3 and 4 are to set up battery group address.

Dip switch 2, 3 and 4 on master battery (first battery) are to set up or change the group address.

**NOTE:** "1" is upper position and "0" is bottom position.

| Dip 1  | Dip 2 | Dip 3 | Dip 4 | Group address   |
|--|-------|-------|-------|---|
| 1: RS485<br>baud<br>rate=9600<br><br><b>Restart to<br/>take effect</b> | 0     | 0     | 0     | Single group only. It's necessary to set up master battery with this setting and slave batteries are unrestricted.                            |
|  | 1     | 0     | 0     | Multiple group condition. It's necessary to set up master battery on the first group with this setting and slave batteries are unrestricted.  |
|  | 0     | 1     | 0     | Multiple group condition. It's necessary to set up master battery on the second group with this setting and slave batteries are unrestricted. |
|  | 1     | 1     | 0     | Multiple group condition. It's necessary to set up master battery on the third group with this setting and slave batteries are unrestricted.  |
|  | 0     | 0     | 1     | Multiple group condition. It's necessary to set up master battery on the forth group with this setting and slave batteries are unrestricted.  |
|  | 1     | 0     | 1     | Multiple group condition. It's necessary to set up master battery on the fifth group with this setting and slave batteries are unrestricted.  |

**NOTE:** The maximum groups of lithium battery is 5 and for maximum number for each group, please check with battery manufacturer.

**4. Installation and Operation**

**LIO-4805/LIO-4810-150A/ESS LIO-I 4810**

After ID no. is assigned for each battery module, please set up LCD panel in inverter and install the wiring connection as following steps.

Step 1: Use supplied RJ11 signal cable to connect into the extension port ( P1 or P2 ).

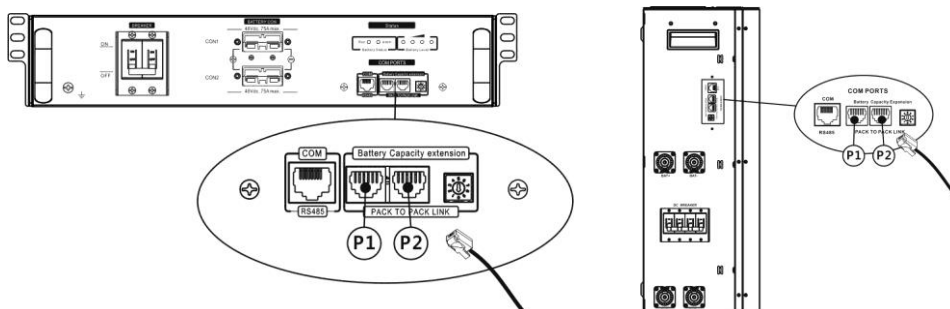

Step 2: Use supplied RJ45 cable (from battery module package) to connect inverter and Lithium battery.

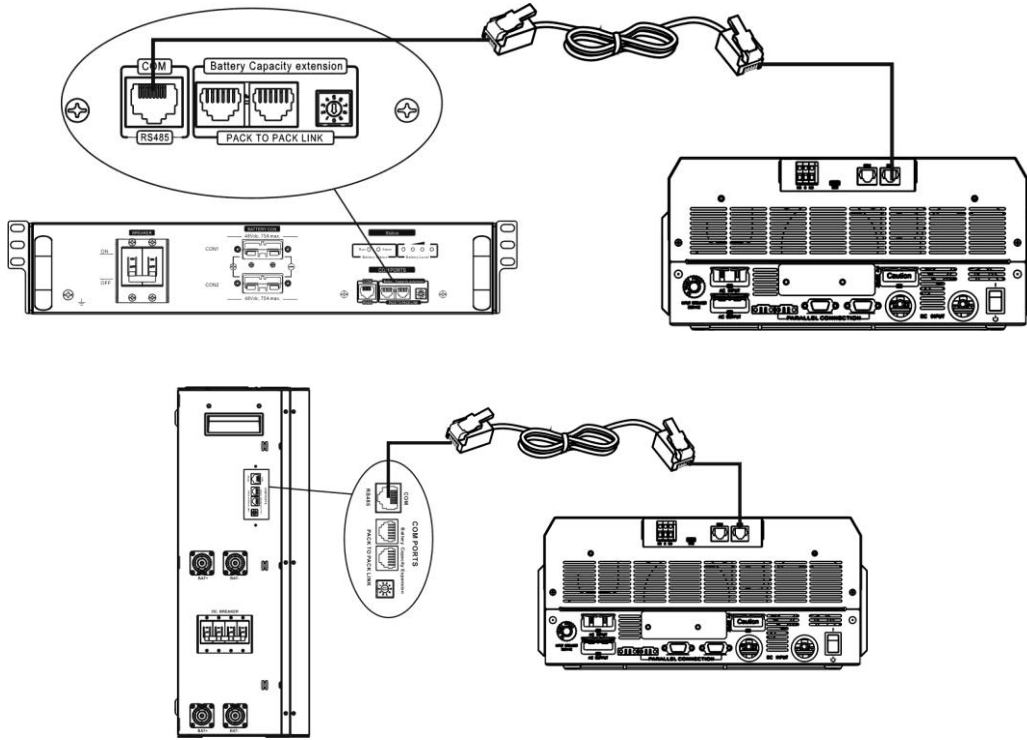

\* For multiple battery connection, please check battery manual for the details.

**Note for parallel system:**

1. Only support common battery installation.
2. Use custom-made RJ45 cable to connect any inverter (no need to connect to a specific inverter) and Lithium battery. Simply set this inverter battery type to "LIB" in LCD program 5. Others should be "USE".

Step 3: Turn the breaker switch "ON". Now, the battery module is ready for DC output.

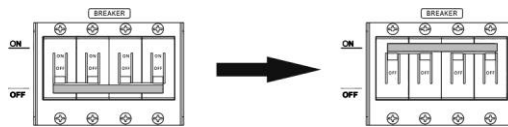

Step 4: Press Power on/off button on battery module for 5 secs, the battery module will start up.

\*If the manual button cannot be approached, just simply turn on the inverter module. The battery module will be automatically turned on.

Step 5: Turn on the inverter.

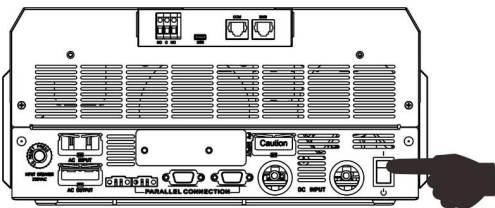

Step 6. Be sure to select battery type as "LIB" in LCD program 5.

05

SETTING LIB



If communication between the inverter and battery is successful, the battery icon on LCD display will flash. Generally speaking, it will take longer than 1 minute to establish communication.

### **PYLONTECH**

After configuration, please set up LCD panel in inverter and make wiring connection to Lithium battery as the following steps.

Step 1. Use custom-made RJ45 cable to connect inverter and Lithium battery.

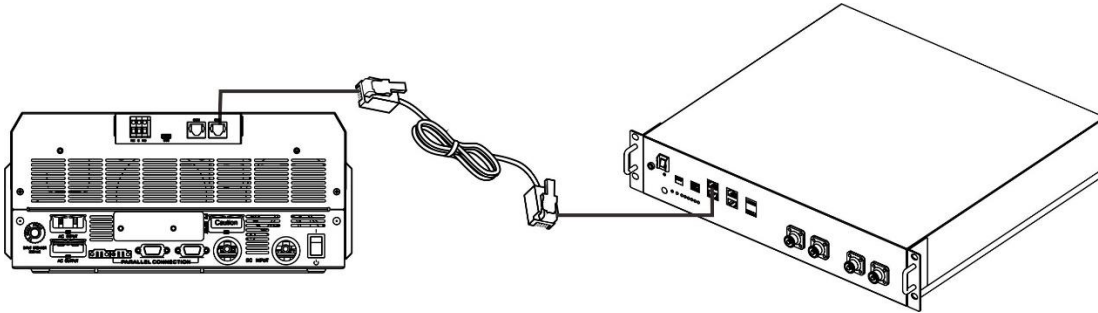

### **Note for parallel system:**

3. Only support common battery installation.
4. Use custom-made RJ45 cable to connect any inverter (no need to connect to a specific inverter) and Lithium battery. Simply set this inverter battery type to "PYL" in LCD program 5. Others should be "USE".

Step 2. Switch on Lithium battery.

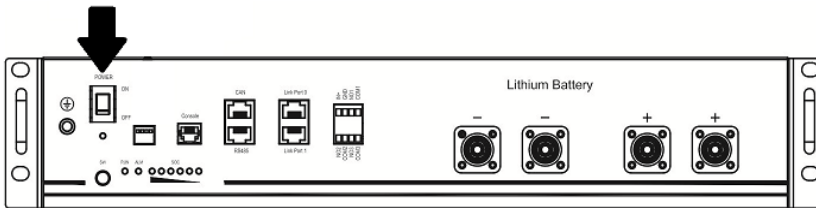

Step 3. Press more than three seconds to start Lithium battery, power output ready.

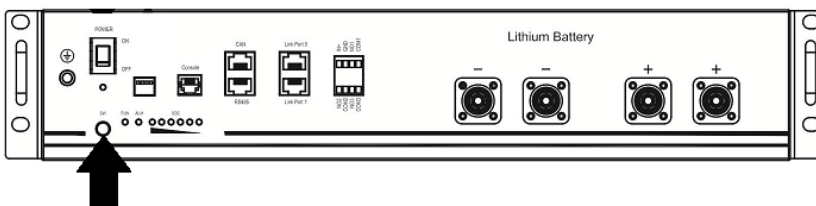

Step 4. Turn on the inverter.

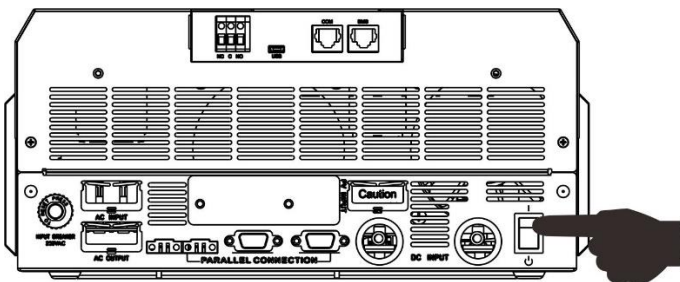



Step 5. Be sure to select battery type as "PYL" in LCD program 14.

05



### WECO

Step 1. Use custom-made RJ45 cable to connect inverter and Lithium battery.

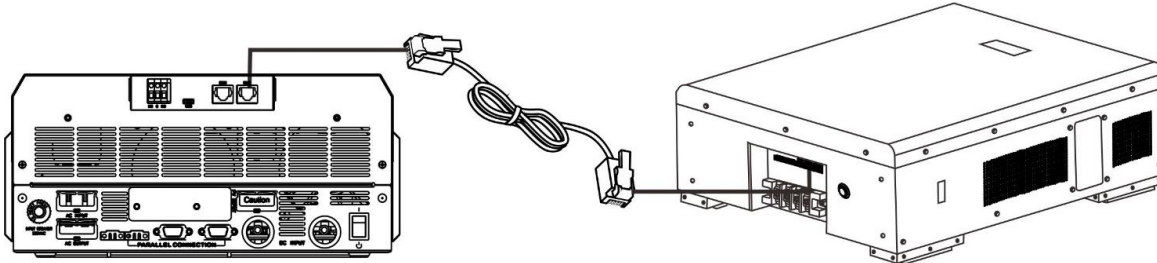

### Note for parallel system:

1. Only support common battery installation.
2. Use custom-made RJ45 cable to connect any inverter (no need to connect to a specific inverter) and Lithium battery. Simply set this inverter battery type to "WEC" in LCD program 5. Others should be "USE".

Step 2. Switch on Lithium battery.

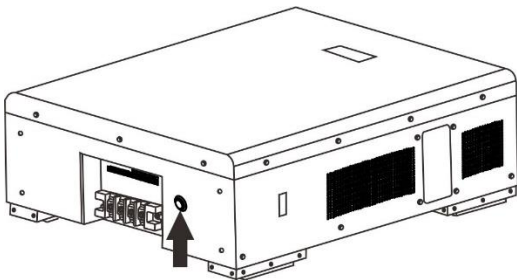

Step 3. Turn on the inverter.

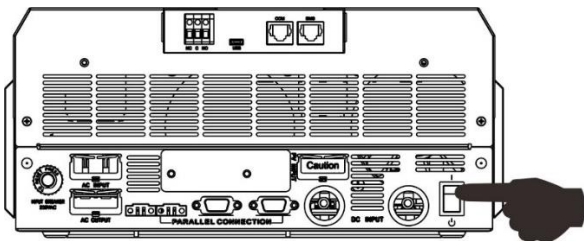

Step 4. Be sure to select battery type as "WEC" in LCD program 5.

05



### SOLTARO

Step 1. Use custom-made RJ45 cable to connect inverter and Lithium battery.



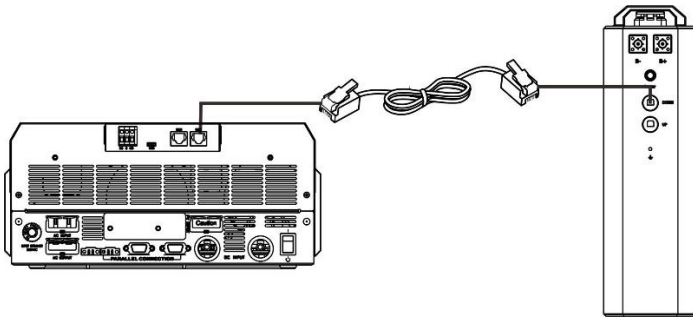

**Note for parallel system:**

1. Only support common battery installation.
2. Use custom-made RJ45 cable to connect any inverter (no need to connect to a specific inverter) and Lithium battery. Simply set this inverter battery type to "SOL" in LCD program 5. Others should be "USE".

Step 2. Open DC isolator and switch on Lithium battery.

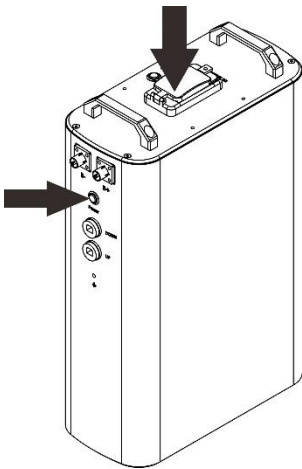

Step 3. Turn on the inverter.

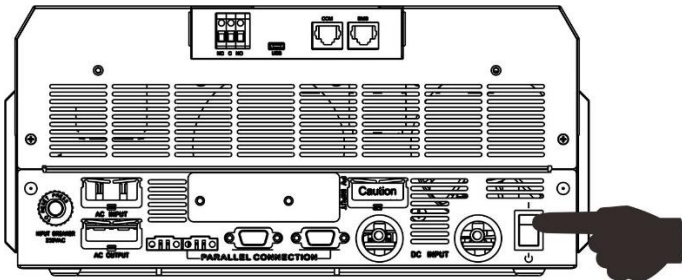

Step 4. Be sure to select battery type as "SOL" in LCD program 5.

05

SETTING SOL





#### 4. LCD Display Information

Press "UP" or "DOWN" key to switch LCD display information. It will show battery pack and battery group number before "Main CPU version checking" as below screen.

| Selectable information                       | LCD display  |
|--|--|
| Battery pack numbers & Battery group numbers | <p>Battery pack numbers = 3, battery group numbers = 1</p>  <p>The LCD display shows the following information:         <ul style="list-style-type: none"> <li>Top left: Battery status icons (AGM, BATT, UPS).</li> <li>Top center: Battery voltage 50.4 V.</li> <li>Top right: Battery pack numbers = 3, battery group numbers = 1.</li> <li>Center: AC output voltage 230 V and frequency 500 Hz.</li> <li>Bottom: Model number P03601.</li> <li>Bottom right: Power output indicators for V, A, and W.</li> </ul> </p> |

#### 5. Code Reference

Related information code will be displayed on LCD screen. Please check inverter LCD screen for the operation.

| Code   | Description  |
|--|--|
| 60    | If battery status is not allowed to charge and discharge after the communication between the inverter and battery is successful, it will show code 60 to stop charging and discharging battery.  |
| 61  | <p>Communication lost (only available when the battery type is setting as "Pylontech Battery" or "WECO Battery" or "Soltaro Battery")</p> <ul style="list-style-type: none"> <li>After battery is connected, communication signal is not detected for 3 minutes, buzzer will beep. After 10 minutes, inverter will stop charging and discharging to lithium battery.</li> <li>Communication lost occurs after the inverter and battery is connected successfully, buzzer beeps immediately.</li> </ul> |
| 69  | If battery status is not allowed to charge after the communication between the inverter and battery is successful, it will show code 69 to stop charging battery.  |
| 70  | If battery status must to charge after the communication between the inverter and battery is successful, it will show code 70 to charge battery.   |
| 71  | If battery status is not allowed to discharge after the communication between the inverter and battery is successful, it will show code 71 to stop discharge battery.  |

# Appendix III: The Wi-Fi Operation Guide in Remote Panel

## 1. Introduction

Wi-Fi module can enable wireless communication between off-grid inverters and monitoring platform. Users have complete and remote monitoring and controlling experience for inverters when combining Wi-Fi module with SolarPower APP, available for both iOS and Android based device. All data loggers and parameters are saved in iCloud.

The major functions of this APP:

- Delivers device status during normal operation.
- Allows to configure device setting after installation.
- Notifies users when a warning or alarm occurs.
- Allows users to query inverter history data.

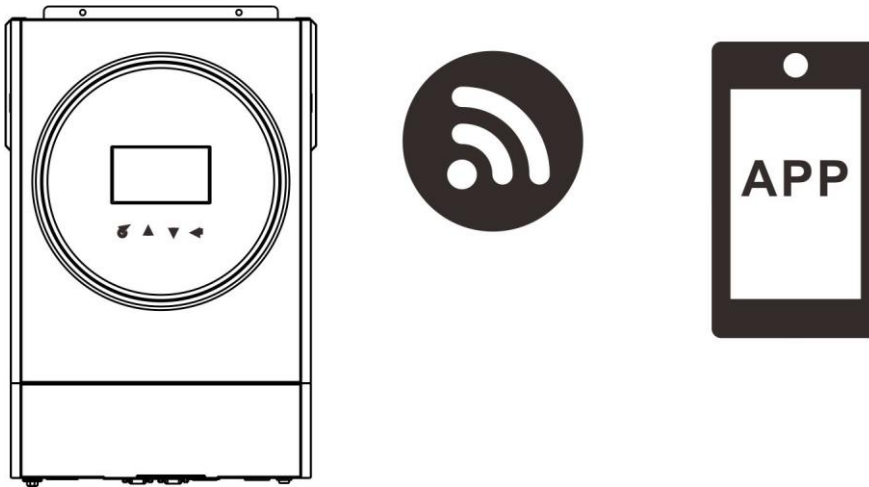

## 2. SolarPower App

### 2-1. Download and install APP

***Operating system requirement for your smart phone:***

🍏 iOS system supports iOS 9.0 and above

🤖 Android system supports Android 5.0 and above

Please scan the following QR code with your smart phone and download SolarPower App.



Android system





iOS system

Or you may find "SolarPower" app from the Apple® Store or "SolarPower Wi-Fi" in Google® Play Store.



### 2-2. Initial Setup

Step 1: Registration at first time

After the installation, please tap the shortcut icon  to access this APP on your mobile screen. In the screen, tap "Register" to access "User Registration" page. Fill in all required information and scan the remote box PN by tapping  icon. Or you can simply enter PN directly. Then, tap "Register" button.

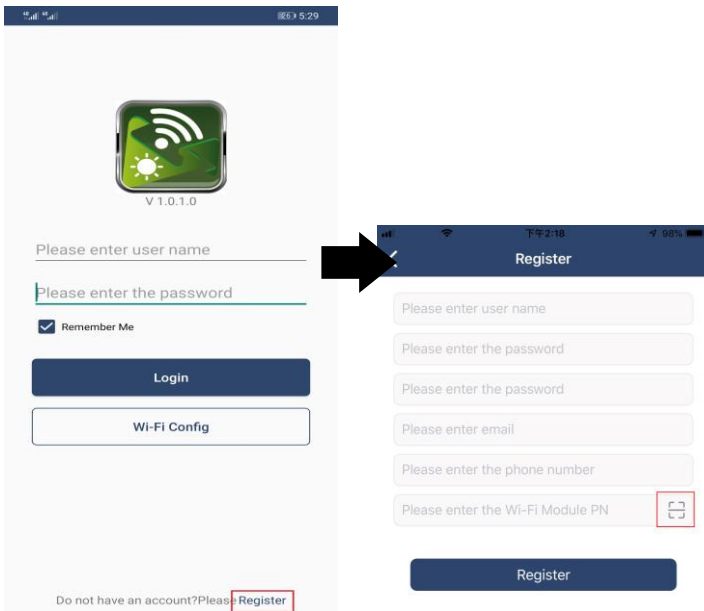

Then, a “Registration success” window will pop up. Tap “Go now” to continue setting local Wi-Fi network connection.

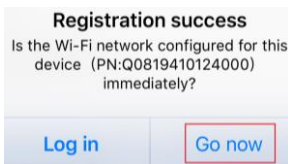

### Step 2: Local Wi-Fi Module Configuration

Now, you are in “Wi-Fi Config” page. There are detailed setup procedure listed in “How to connect?” section and you may follow it to connect Wi-Fi.

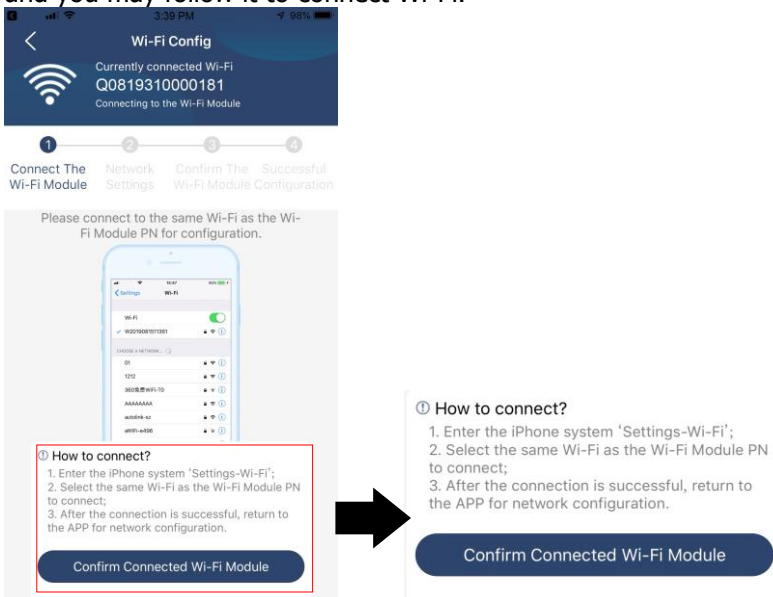

Enter the “Settings→Wi-Fi” and select connected Wi-Fi name. The connected Wi-Fi name is the same to your Wi-Fi PN number and enter default password “12345678”.

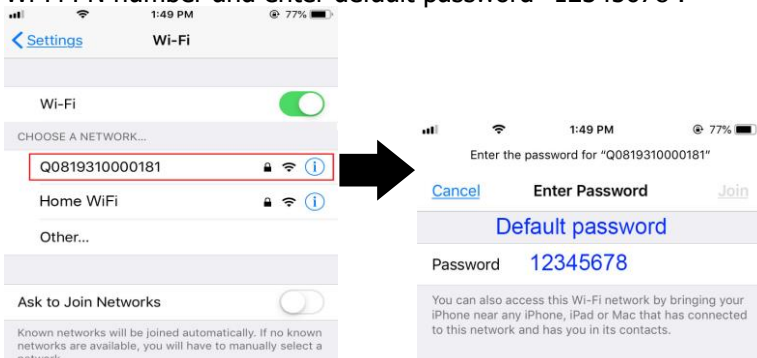

Then, return to SolarPower APP and tap “  ” button when Wi-Fi module is connected successfully.

**Step 3: Wi-Fi Network settings**

Tap  icon to select your local Wi-Fi router name (to access the internet) and enter password.

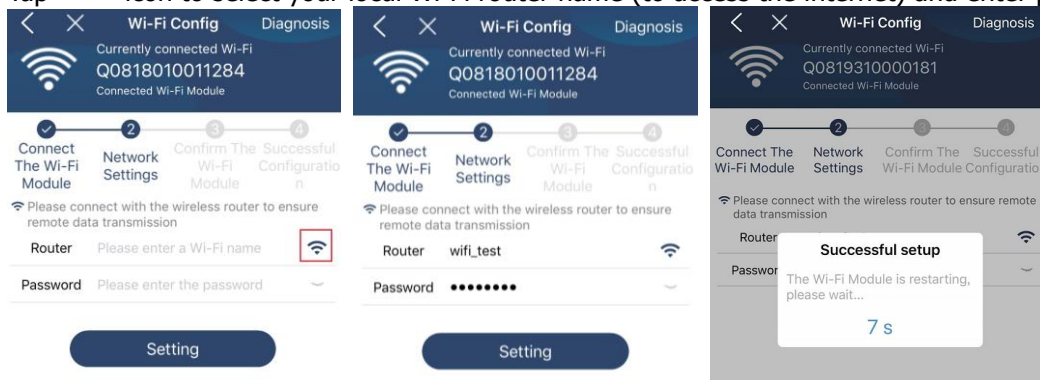

**Step 4: Tap “Confirm” to complete the Wi-Fi configuration between the Wi-Fi module and the Internet.**

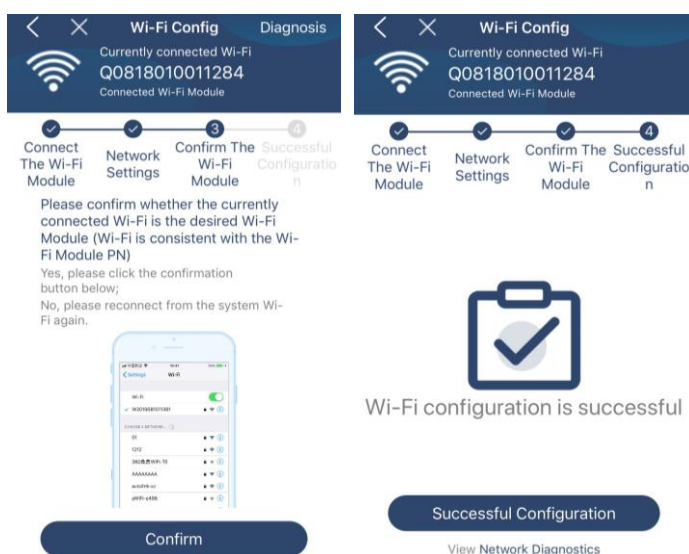

If the connection fails, please repeat Step 2 and 3.

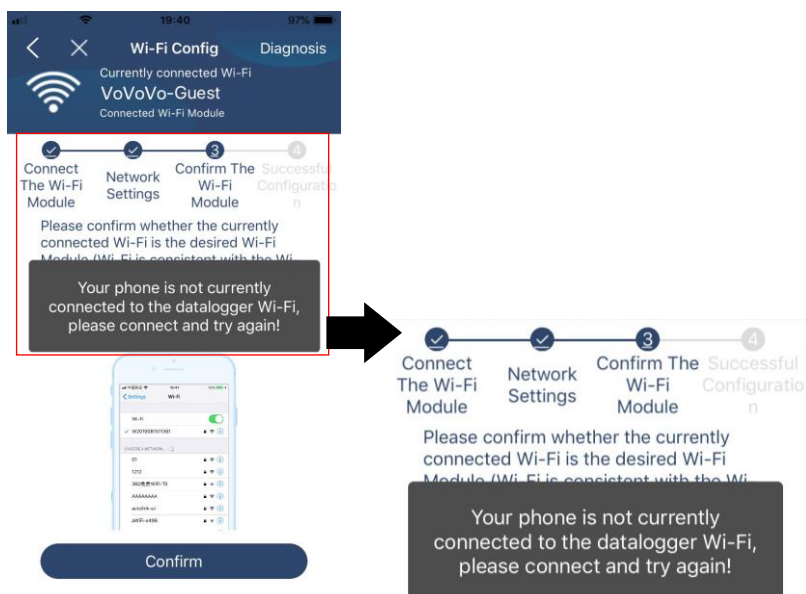

**Diagnose Function**

If the module is not monitoring properly, please tap “  ” on the top right corner of the screen for further details. It will show repair suggestion. Please follow it to fix the problem. Then, repeat the steps in the chapter 4.2 to re-set network setting. After all setting, tap “Rediagnosis” to re-connect again.

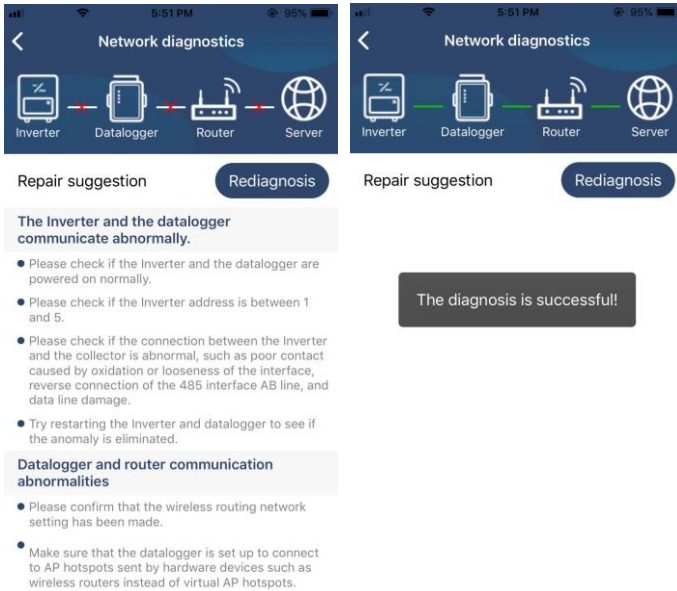

### 2-3. Login and APP Main Function

After finishing the registration and local Wi-Fi configuration, enter registered name and password to login.

Note: Tick "Remember Me" for your login convenience afterwards.

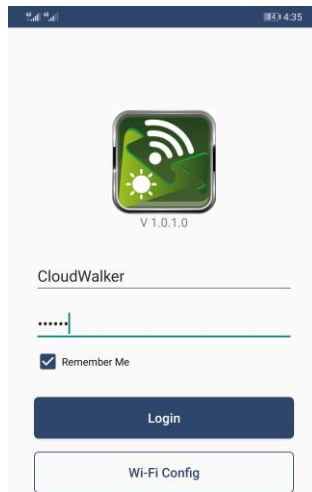

### Overview

After login is successfully, you can access "Overview" page to have overview of your monitoring devices, including overall operation situation and Energy information for Current power and Today power as below diagram.

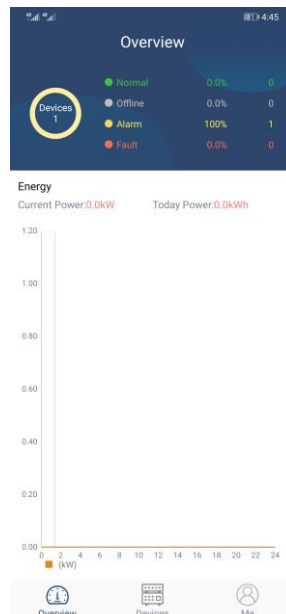

## Devices

Tap the  icon (located on the bottom) to enter Device List page. You can review all devices here by adding or deleting Wi-Fi Module in this page.

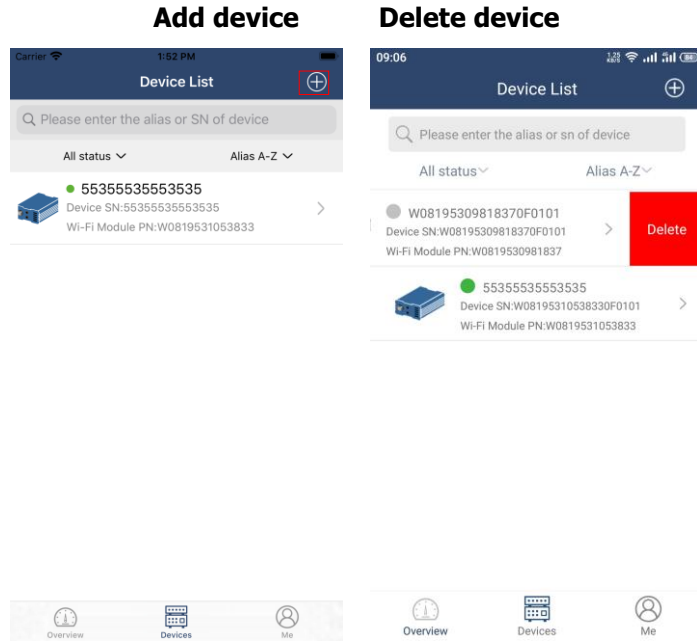

Tap  icon on the top right corner and manually enter part number to add device. This part number label is pasted on the bottom of inverter. After entering part number, tap "Confirm" to add this device in the Device list.

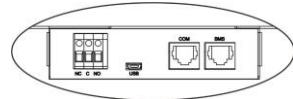
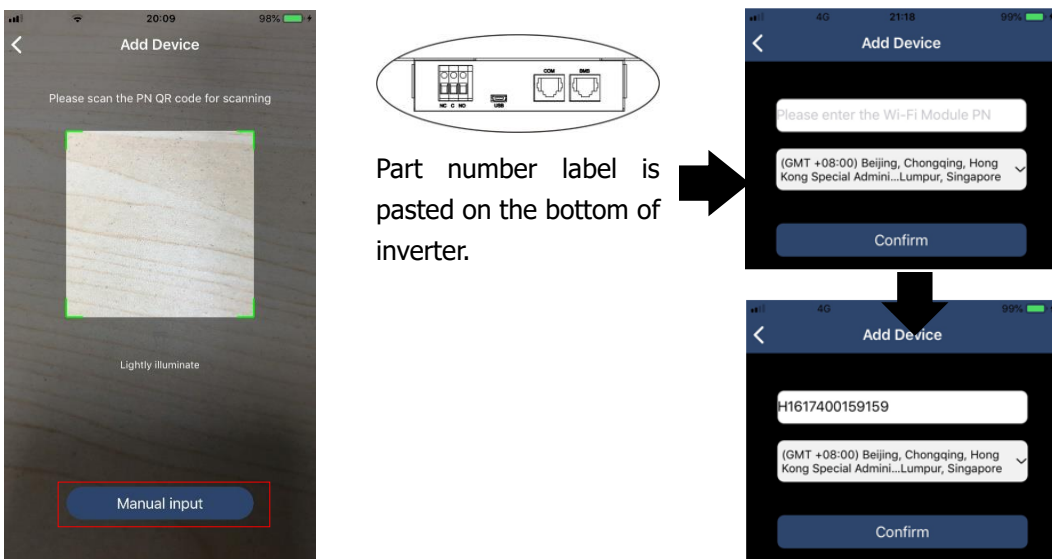

Part number label is pasted on the bottom of inverter.

For more information about Device List, please refer to the section 2.4.

## ME

In ME page, users can modify "My information", including **【User's Photo】**, **【Account security】**, **【Modify password】**, **【Clear cache】**, and **【Log-out】**, shown as below diagrams.

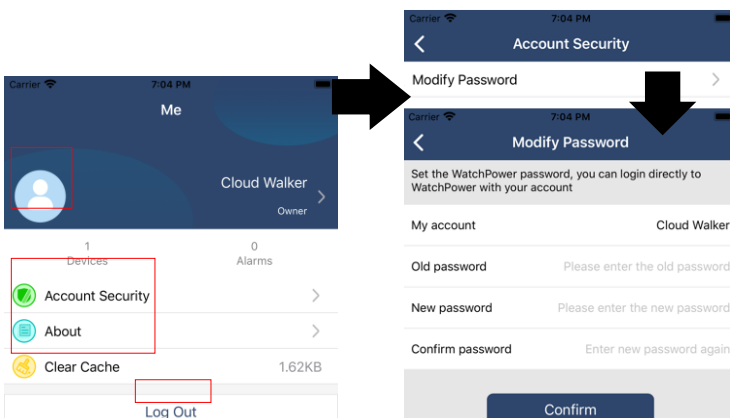



## 2-4. Device List

In Device List page, you can pull down to refresh the device information and then tap any device you want to check up for its real-time status and related information as well as to change parameter settings. Please refer to the parameter setting list.

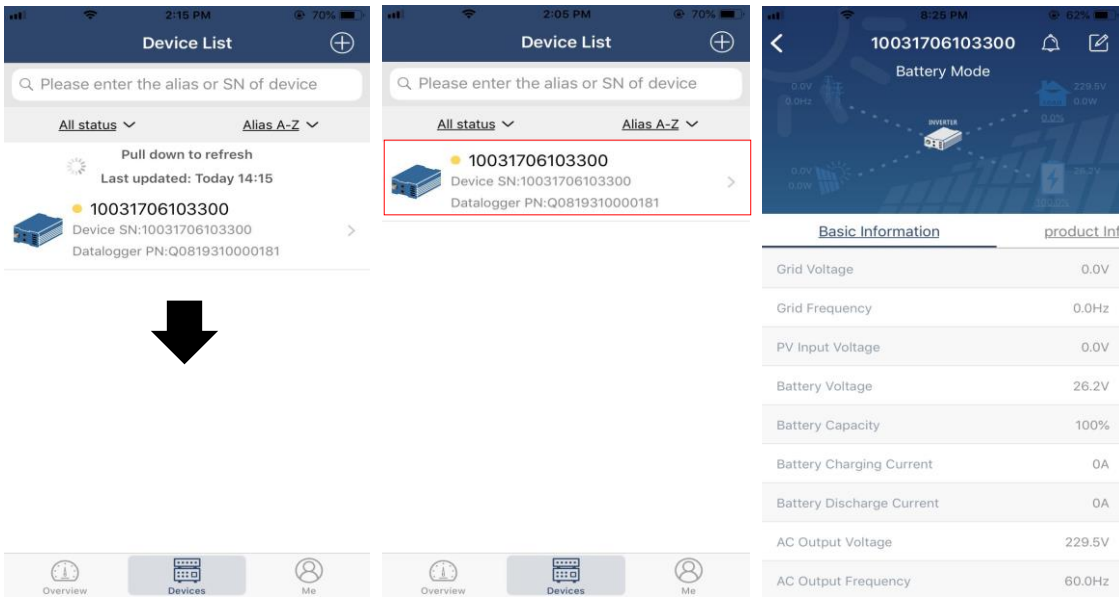

### Device Mode

On the top of screen, there is a dynamic power flow chart to show live operation. It contains five icons to present PV power, inverter, load, utility and battery. Based on your inverter model status, there will be **【Standby Mode】**, **【Line Mode】**, **【Battery Mode】**.

**【Standby Mode】** Inverter will not power the load until "ON" switch is pressed. Qualified utility or PV source can charge battery in standby mode.





**【Line Mode】** Inverter will power the load from the utility with or without PV charging. Qualified utility or PV source can charge battery.



**【Battery Mode】** Inverter will power the load from the batter with or without PV charging. Only PV source can charge battery.



### Device Alarm and Name Modification

In this page, tap the  icon on the top right corner to enter the device alarm page. Then, you can review alarm history and detailed information. Tap the  icon on the top right corner, a blank input box will pop out. Then, you can edit the name for your device and tap "Confirm" to complete name modification.



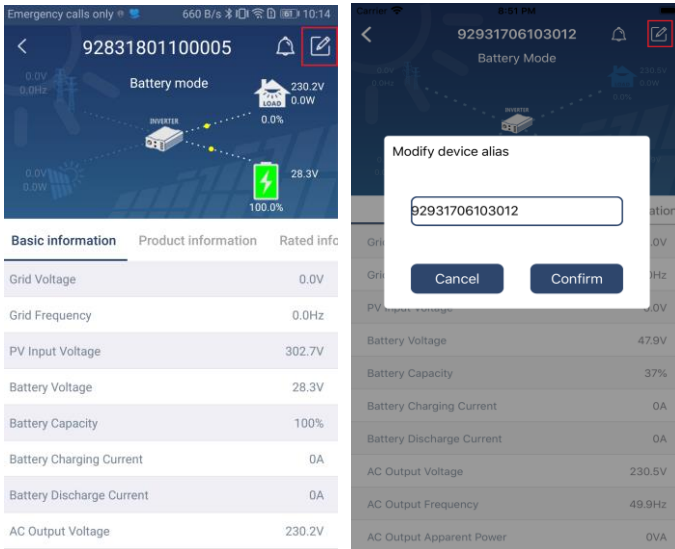

### Device Information Data

Users can check up **【Basic Information】** , **【Product Information】** , **【Rated information】** , **【History】** , and **【Wi-Fi Module Information】** by swiping left.

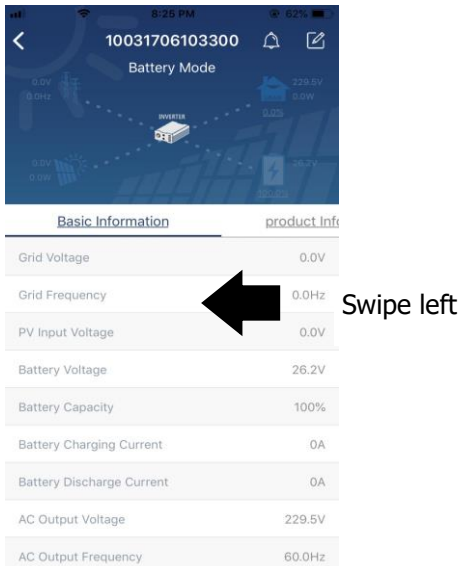

**【Basic Information】** displays basic information of the inverter, including AC voltage, AC frequency, PV input voltage, Battery voltage, Battery capacity, Charging current, Output voltage, Output frequency, Output apparent power, Output active power and Load percent. Please slide up to see more basic information.

**【Production Information】** displays Model type (Inverter type), Main CPU version, Bluetooth CPU version and secondary CPU version.

**【Rated Information】** displays information of Nominal AC voltage, Nominal AC current, Rated battery voltage, Nominal output voltage, Nominal output frequency, Nominal output current, Nominal output apparent power and Nominal output active power. Please slide up to see more rated information.

**【History】** displays the record of unit information and setting timely.

**【Wi-Fi Module Information】** displays of Wi-Fi Module PN, status and firmware version.

### Parameter Setting

This page is to activate some features and set up parameters for inverters. Please be noted that the listing in "Parameter Setting" page in below diagram may differ from the models of monitored inverter. Here will briefly highlight some of it, **【Output Setting】**, **【Battery Parameter Setting】**, **【Enable/ Disable items】**, **【Other Settings】**, **【Restore to the defaults】** to illustrate.

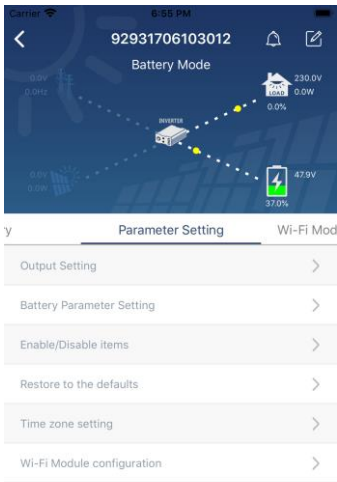

There are three ways to modify setting and they vary according to each parameter.

- a) Listing options to change values by tapping one of it.
  - b) Activate/Shut down functions by clicking "Enable" or "Disable" button.
  - c) Changing values by clicking arrows or entering the numbers directly in the column.
- Each function setting is saved by clicking "Set" button.

Please refer to below parameter setting list for an overall description and be noted that the available parameters may vary depending on different models. Please always see the original product manual for detailed setting instructions.

**Parameter setting list:**

| Item                      |                           | Description   |
|---------------------------|---------------------------|---|
| Output setting            | Output source priority    | To configure load power source priority.                            |
|                           | AC input range            | Input voltage range selection                                       |
|                           | Output voltage            | To set output voltage.  |
|                           | Output frequency          | To set output frequency.  |
| Battery parameter setting | Battery Type              | Select connected battery type                                       |
|                           | Battery Cut-off Voltage   | Set battery cut-off voltage   |
|                           | Bulk Charging Voltage     | Set battery bulk charging voltage                                   |
|                           | Battery Float Voltage     | Set battery floating charging voltage                               |
|                           | Max Charging Current      | To configure total charging current for solar and utility chargers. |
|                           | Max AC Charging Current   | Set maximum utility charging current                                |
|                           | Charging Source Priority  | To configure charger source priority                                |
|                           | Back To Grid Voltage      | Set battery voltage to stop discharging when grid is available      |
|                           | Back To Discharge Voltage | Set battery voltage to stop charging when grid is available         |
| Enable/Disable Functions  | Overload Auto Restart     | If disabled, the unit won't be restarted after overload occurs.     |

|                        |  |   |
|------------------------|--|---|
|                        | Overload Temperature Auto Restart                                  | If disabled, the unit won't be restarted after over-temperature fault is solved.  |
|                        | Overload Bypass  | If enabled, the unit will enter bypass mode when overload occurs.   |
|                        | Beeps While Primary Source Interrupt                               | If enabled, buzzer will alarm when primary source is abnormal.  |
|                        | Buzzer   | If disabled, buzzer won't be on when alarm/fault occurred.  |
|                        | Backlight  | If disabled, LCD backlight will be off when panel button is not operated for 1 minute.  |
|                        | LCD Screen Return To Default Display                               | If selected, no matter how users switch display screen, it will automatically return to default display screen (Input voltage /output voltage) after no button is pressed for 1 minute. |
|                        | Fault Code Record  | If enabled, fault code will be recorded in the inverter when any fault happens.   |
|                        | Solar Feed To Grid   | If selected, solar energy is allowed to feed to the grid.   |
| Other Settings         | Solar Supply Priority  | Set solar power as priority to charge the battery or to power the load.   |
|                        | Reset PV Energy Storage  | If clicked, PV energy storage data will be reset.   |
|                        | Start Time For Enable AC Charge Working                            | The setting range of start charging time for AC charger is from 00:00 to 23:00. The increment of each click is 1 hour.  |
|                        | Ending Time For Enable AC Charge Working                           | The setting range of stop charging time for AC charger is from 00:00 to 23:00. The increment of each click is 1 hour.   |
|                        | Scheduled Time For AC Output On                                    | The setting range of scheduled time for AC output on is from 00:00 to 23:00. The increment of each click is 1 hour.   |
|                        | Scheduled Time For AC Output Off                                   | The setting range of scheduled time for AC output off is from 00:00 to 23:00. The increment of each click is 1 hour.  |
|                        | Country Customized Regulations                                     | Select inverter installed area to meet local regulation.  |
|                        | Set Date Time  | Set date time.  |
| Restore to the default | This function is to restore all settings back to default settings. |   |